

# PWi FORGING

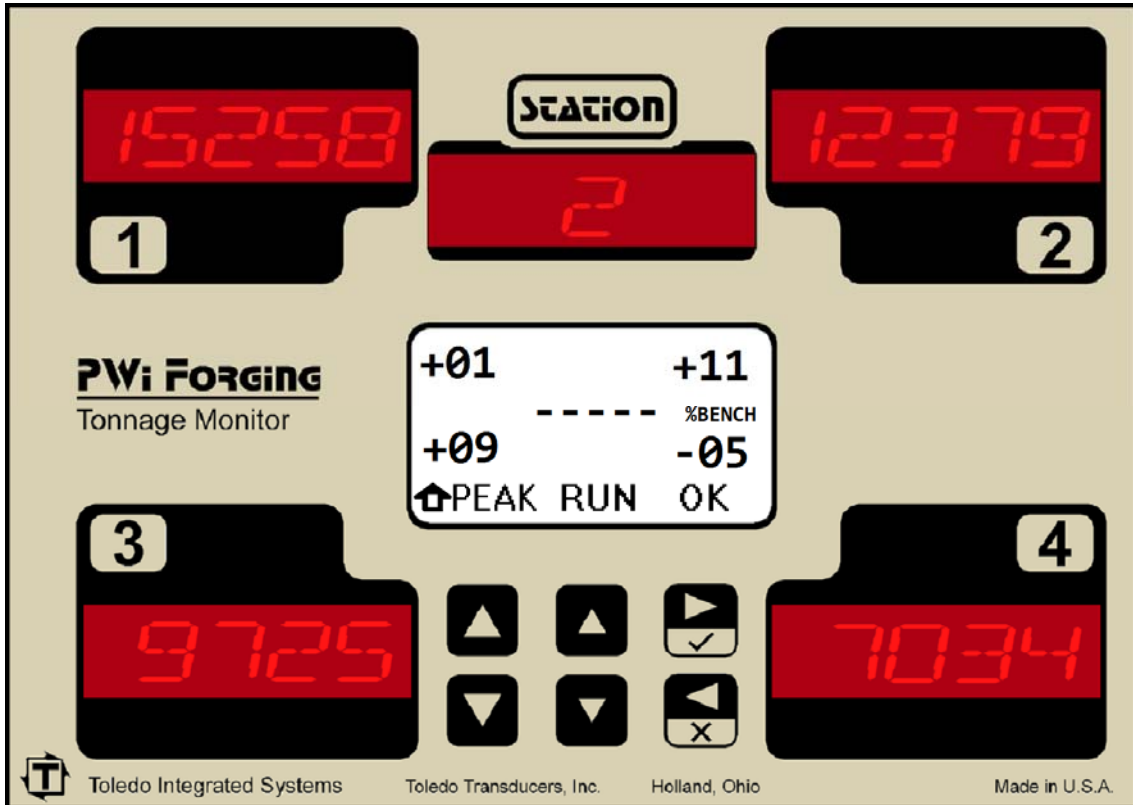

## Tonnage Monitor

By Toledo Integrated Systems

## User's Manual



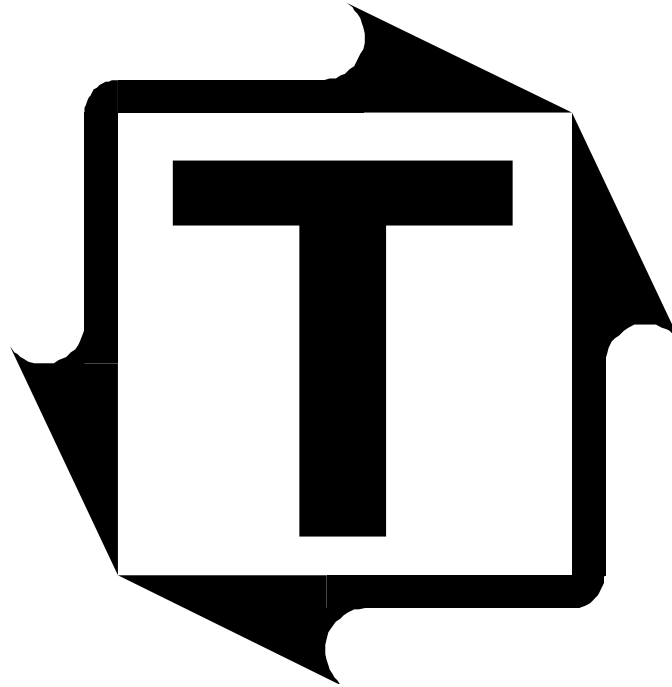

# **PWi Forging User's Manual**

**Revision: A**



Scan to visit us  
on the web

# Table of Contents

<b>1:</b>	<b>Installation .....</b>	<b>5</b>
	Limited Warranty .....	5
	Features Overview .....	6
	Specifications .....	7
	Mounting the PWi Forging – Standard Installation .....	9
	Mounting the PWi Forging – Flush Mount Option .....	10
	PWi Forging Components.....	11
	Conduit Hole Selection.....	12
	AC Power Connection and Configuration .....	13
	DC Power Connection .....	14
	Sensor Input Configuration.....	15
	Load Sensor Connection .....	16
	Sensor Cable Termination .....	17
	Sensors Connection.....	18
	Analog Output.....	19
	Probe Input.....	20
	External Reset Switch Connection .....	22
	Serial Port Connection .....	23
	Shutdown Relays .....	25
<b>2:</b>	<b>Operation .....</b>	<b>27</b>
	User Interface.....	27
	Operation Mode and Configuration Mode.....	28
	The Security Code Feature .....	29
	The Low Battery Indicator.....	30
	Replacing the Backup Battery .....	31
	Operation Mode - Overview .....	32
	Operation Mode - Description .....	33
	<i>Home Menu</i> .....	33
	<i>Signature Menu</i> .....	35
	<i>Setpoint Menu</i> .....	39
	<i>Alarm Menu</i> .....	41
	<i>Reverse Menu</i> .....	42
	<i>Statistics Menu</i> .....	43
	<i>Job Menu</i> .....	45
	<i>Station Menu</i> .....	46
	<i>Security Code Menu (Operation mode)</i> .....	47
	Configuration Mode - Overview.....	50
	Configuration Mode - Description.....	51
	<i>Channel Menu</i> .....	51
	<i>Decimal Point Menu</i> .....	52
	<i>Capacity Menu</i> .....	53
	<i>Trigger Menu</i> .....	54



*Threshold Menu*..... 55  
*Learn Menu* ..... 56  
*Delay Menu* ..... 57  
*Offset Menu* ..... 58  
*Mode Menu*..... 59  
*E-Stop Menu*..... 60  
*Setup Count Menu* ..... 61  
*Address Menu*..... 62  
*Baud Rate Menu* ..... 63  
*Calibration Menu* ..... 64  
*Security Code Menu (Configuration mode)* ..... 65

**3: Calibration Procedure.....69**  
**4: Calibration Information Label.....73**  
**5: Operator's Guide.....75**  
**6: Appendix.....77**  
    I) Sensor Installation (Doc# 11080)..... 77  
    II) Calibration Sheets (Form# 1224)..... 77

# Table of Figures

---

Figure 1.1: Standard Mounting Dimensions.....	9
Figure 1.2: Flush Mount Mounting Dimensions .....	10
Figure 1.3: PWi Forging Components .....	11
Figure 1.4: Conduit Hole Selection .....	12
Figure 1.5: AC Power Connection and Jumper Settings .....	13
Figure 1.6: DC Power Connection.....	14
Figure 1.7: Sensor Configuration Jumper Settings.....	15
Figure 1.8: Sensor Input Locations.....	16
Figure 1.9: Sensor Cable Stripping.....	17
Figure 1.10: Sensor Wiring.....	18
Figure 1.11: Analog Output Wiring.....	19
Figure 1.12: Probe Input Wiring.....	20
Figure 1.13: Probe Timing.....	21
Figure 1.14: External Reset Switch Wiring .....	22
Figure 1.15: Serial Connection .....	23
Figure 1.16: RS232 Serial Port Wiring.....	24
Figure 1.17: RS422 Serial Network Wiring .....	24
Figure 1.18: Shutdown Relay Wiring .....	25



# 1: Installation

---

## Limited Warranty

This unit is warranted by the manufacturer, Toledo Transducers, Inc., to be free of defects in workmanship and materials for one year from date of manufacturer's shipment. This warranty is limited to repairing or replacing products which manufacturer's investigation shows were defective at the time of shipment by the manufacturer.

All products subject to this warranty must be returned for examination, repair or replacement

F.O.B. to: Toledo Transducers, Inc.  
6834 Spring Valley Drive  
Holland, Ohio 43528

***The express warranty set forth herein is in lieu of all other warranties, expressed or implied, including without limitation any warranties of merchant-ability or fitness for a particular purpose. All such warranties are hereby disclaimed and excluded by the manufacturer.***

Repair or replacement of defective products as provided above is the sole and exclusive remedy provided thereunder. The manufacturer shall not be liable for any further loss, damages, or expenses, including incidental or consequential damages, directly or indirectly arising from the sale or use of this product.

Any unauthorized repair voids this warranty.

There are no warranties that extend beyond those expressly set forth herein.



## Features Overview

The PWi Forging is a full-featured load monitor that interfaces with load sensors to provide force measurement for press protection and quality control. Unlike traditional tonnage monitors, the PWi Forging monitor is designed for the specific needs of forging applications. The total press load is displayed on high-visibility 7-segment LED displays for up to four forging stations. The user interface consists of six tactile switches and a back-lit LCD graphic display module that provides a user-friendly menu system. The LCD is also used to show deviation, alarm data, settings, and much more.

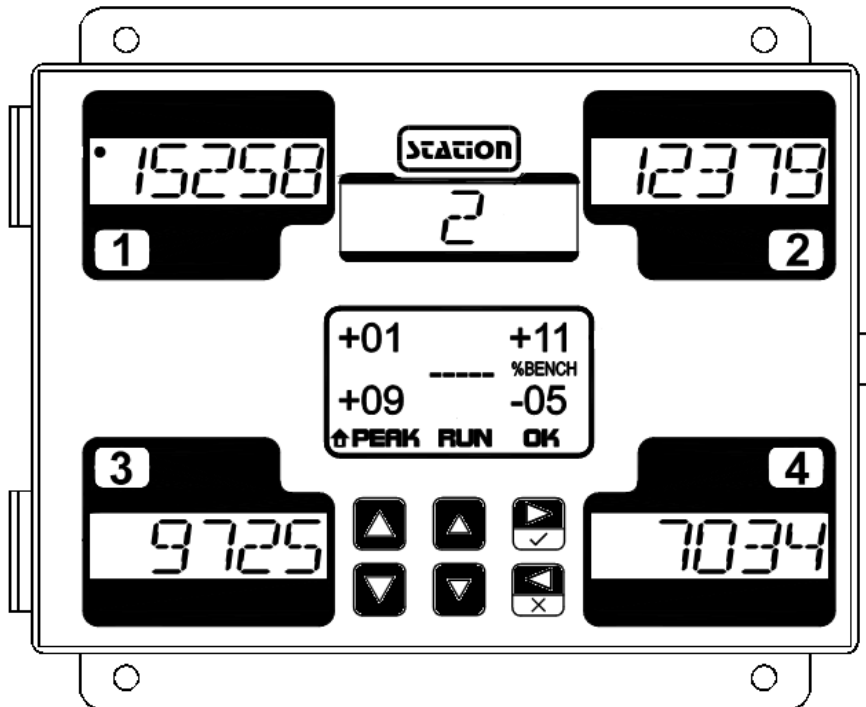

### FEATURES

- 4 channel load monitoring
- Reverse load
- LCD graphic display with back-lighting
- 5-digit LED display for each channel
- Menu-driven user interface
- Load signatures
- 2 shutdown relays (Top-Stop and E-Stop)
- 100 job storage
- One RS422 serial port
- PressNet Software compatible
- Compact dust-proof enclosure

### OPTIONS

- 24VDC power input
- Mounting bracket for angle viewing





## Specifications

<b>Load Input</b>	No. of Channels	Four standard (Two optional)
	Sensor Inputs	Full bridge strain gage sensors 120 to 1,000 ohms Up to (8) 350 ohm sensors
	Sensor Excitation	Built-in 12VDC @ 300mA max (Short circuit protected)
	Sensor Input Connections	5-pin .15" pitch Phoenix connector
	Balance Adjustment	25-turn potentiometer
	Balance Range	+/- 1mV/V of offset
	Gain Adjustment	25-turn potentiometer
	Gain Range	Low Gain = 50 to 550 times High Gain = 500 to 5,500 times
	Analog Output	1.25VDC @ Press Capacity
	Analog Output Connection	9-pin sub-D connector
	Inaccuracy	+/- 1% of full scale max
	Non-linearity	+/- .1% of full scale max
	Frequency Response	Flat DC to 6 KHz
	Resolution	Each channel provides a 5-digit load value in 1024 count resolution
Calibration Shunts	1 Meg Ohm, 0.1% resistor	
<b>Job Storage</b>		100 jobs
<b>Speed Limit</b>		Up to 400 SPM with threshold trigger Up to 2,000 SPM with probe trigger
<b>User Interface</b>	Display	Back-lit 1.5"x2.75" LCD graphical display (64x128 pixel) (5) LED displays, each consisting of five 7-segment displays
	Keypad	Menu-driven keypad consisting of six tactile switches
<b>Computer Interface</b>	Serial Port 1	RS422 (9,600 to 115,200 baud) for PressNet software interface
	Serial Port 2 & 3 (Optional)	RS422 (9,600 to 115,200 baud) for data transfer
<b>Probe Input</b>		Built-in voltage source (12VDC, 50 mA max) provides power for the probe. It supports NPN or PNP proximity probes, and solid state or dry contact relay.
<b>Shutdown Relays</b>	Top Stop relay and E-Stop relay	Mechanical relay with N.O. and N.C. contacts 8 AMP @ 250VAC or 30VDC



<b>Supply Power (AC units)</b>	Requirements	30 Watts max 85-132VAC @ 50-60Hz or 170-264VAC @ 50-60Hz Power Input is jumper selectable
	Fuse	0.5A for 110VAC input 0.25A for 220VAC input TR5 type, Slow-Blow
<b>Supply Power (DC units)</b>	Requirements	24VDC @ 1.25A minimum
	Fuse	1.25A TR5 type, Slow-Blow
<b>Data Storage</b>	Configuration/Jobs	Nonvolatile Data Flash
	Live data (Counters, peak load)	3V Lithium Battery – Type CR-1/3N
<b>Operating Temperature</b>		0 to 70 degrees Celsius
<b>Dimensions</b>		8.90" W x 6.88" H x 5.00" D, or 226mm W x 175mm H x 127mm D



## Mounting the PWi Forging – Standard Installation

*Note: This section is for mounting standard PWi Forging units. If the flush mount option was purchased, refer to the next section for instructions on mounting the PWi Forging with the flush mount option.*

The PWi Forging is an electronic instrument and must therefore be protected from physical stresses such as shock and vibration. Shock mounts are provided with every standard PWi Forging for this purpose. Failure to use these shock mounts may result in premature failure of the instrument and possibly void your warranty.

The PWi Forging may be mounted directly to the press or to an adjacent structure. It should be positioned so that the display is easily read and the instrument is readily accessible. Figure 1.1 below provides the mounting dimensions and demonstrates the proper attachment of the provided shock mounts.

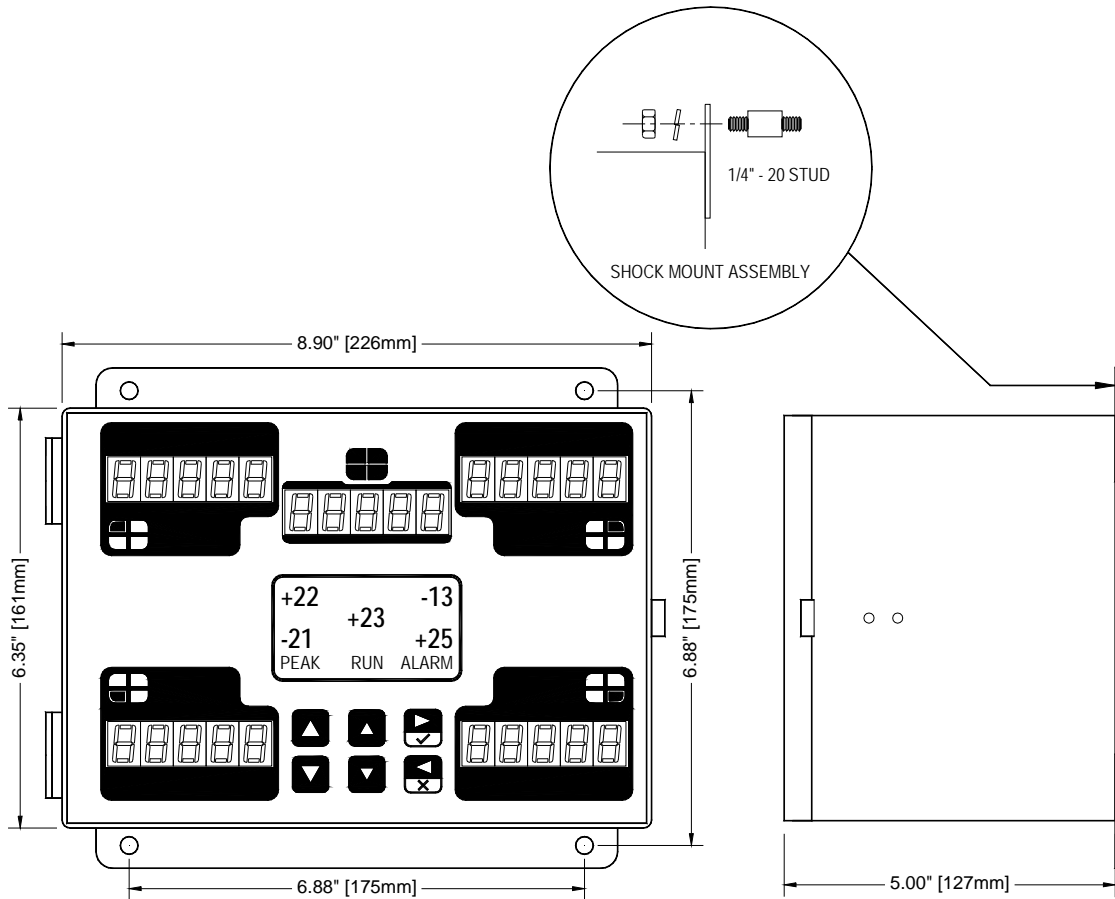

**Figure 1.1: Standard Mounting Dimensions**

### Mounting the PWi Forging – Flush Mount Option

An optional flush mounted installation is possible as shown in Figure 1.2. The flush mount option has built-in anti-shock components; therefore external shock mounts are not required. As with the standard installation, the flush mount option allows the PWi Forging to be mounted directly to the press or to an adjacent structure. It should be positioned so that the display is easily read and the instrument is readily accessible.

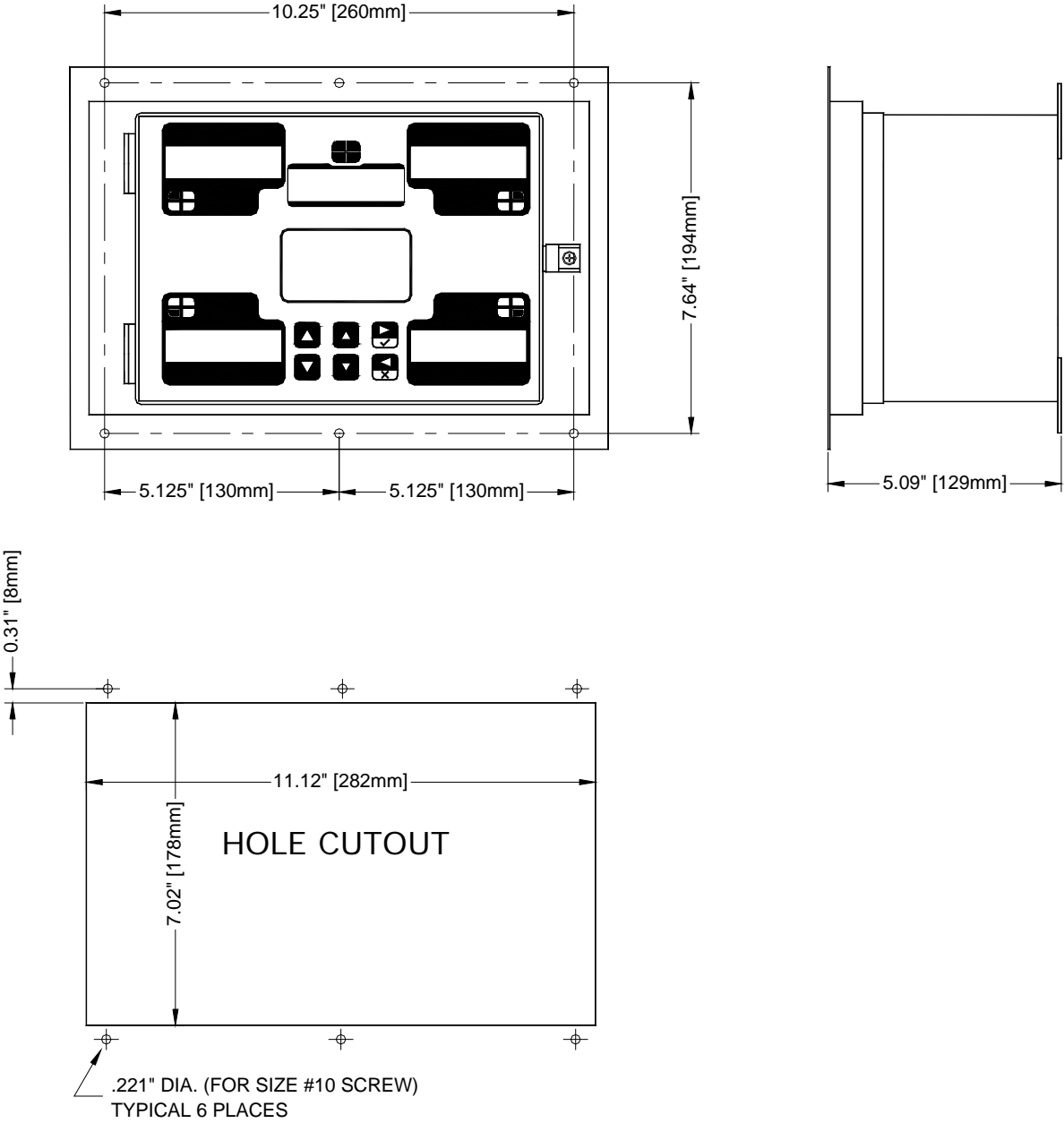
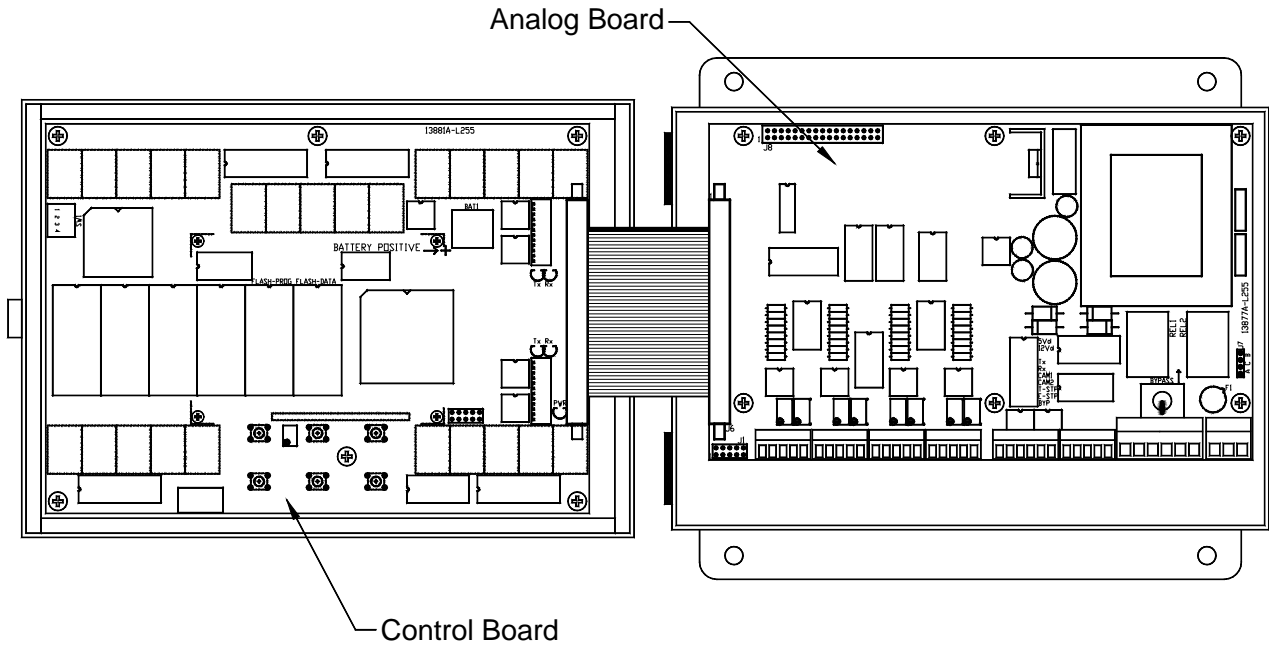

Figure 1.2: Flush Mount Mounting Dimensions

## PWi Forging Components



**Figure 1.3: PWi Forging Components**

# Conduit Hole Selection

Follow Figure 1.4 to select the proper conduit hole for cabling. The holes are for 1/2" conduit, but they can be enlarged in the field if a larger fitting is required.

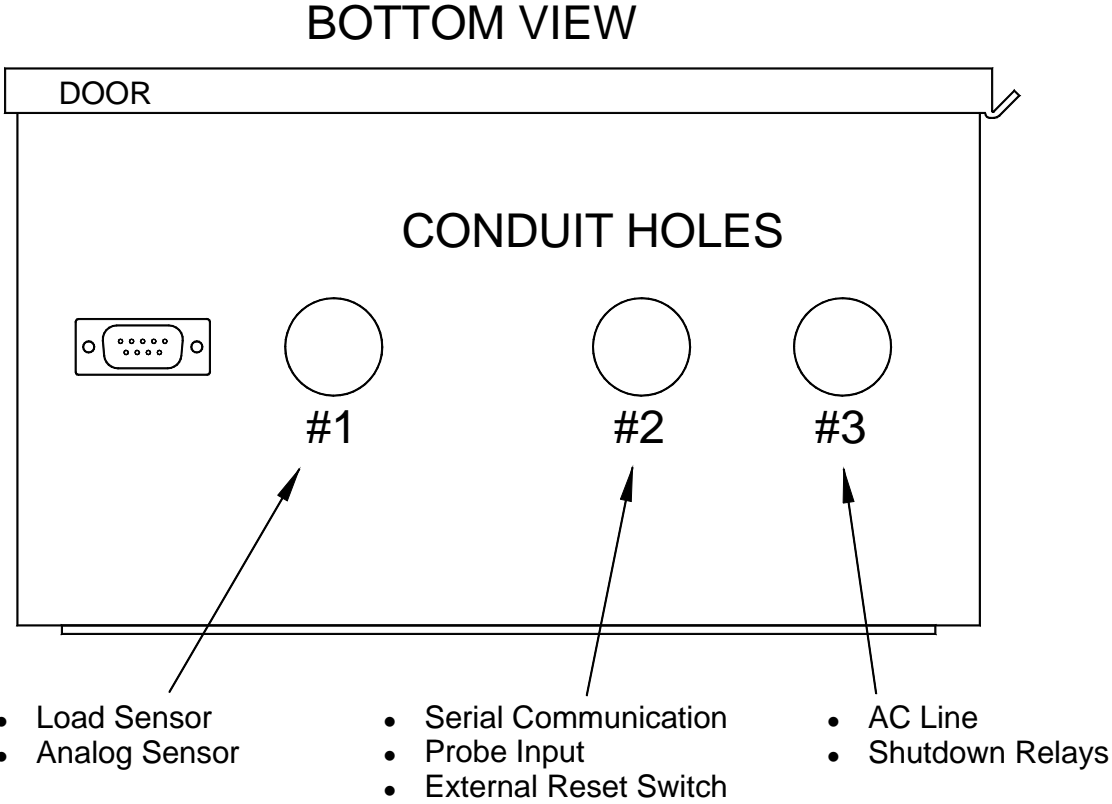

**Figure 1.4: Conduit Hole Selection**



## AC Power Connection and Configuration (AC unit only)

AC power is connected to the PWi Forging's Analog Board as shown in Figure 1.5. Use Conduit Hole #3 (see Figure 1.4) for the AC Power Wiring. Use the proper fuse as indicated.

With the proper jumper settings, the PWi Forging can be powered by either 110 VAC or 220 VAC (Factory set at 110 VAC.) The jumpers are located on the Analog Board as shown below.

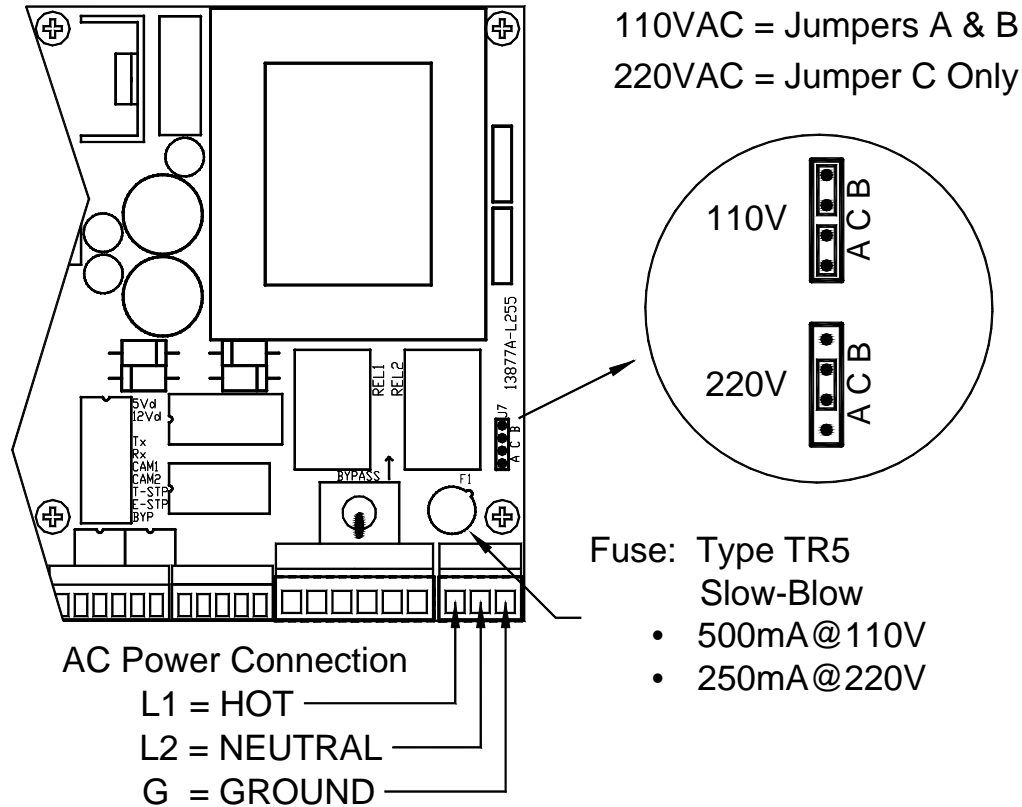

**Figure 1.5: AC Power Connection and Jumper Settings**

### DC Power Connection (DC unit only)

DC power is connected to the PWi Forging's Analog Board as shown in Figure 1.6. The external 24VDC power supply should be rated at 1.25A or higher. Use Conduit Hole #3 (see Figure 1.4) for the DC Power Wiring. Use the proper fuse as indicated. If the power cable has a shield, it can be connected to the Chassis Ground terminal.

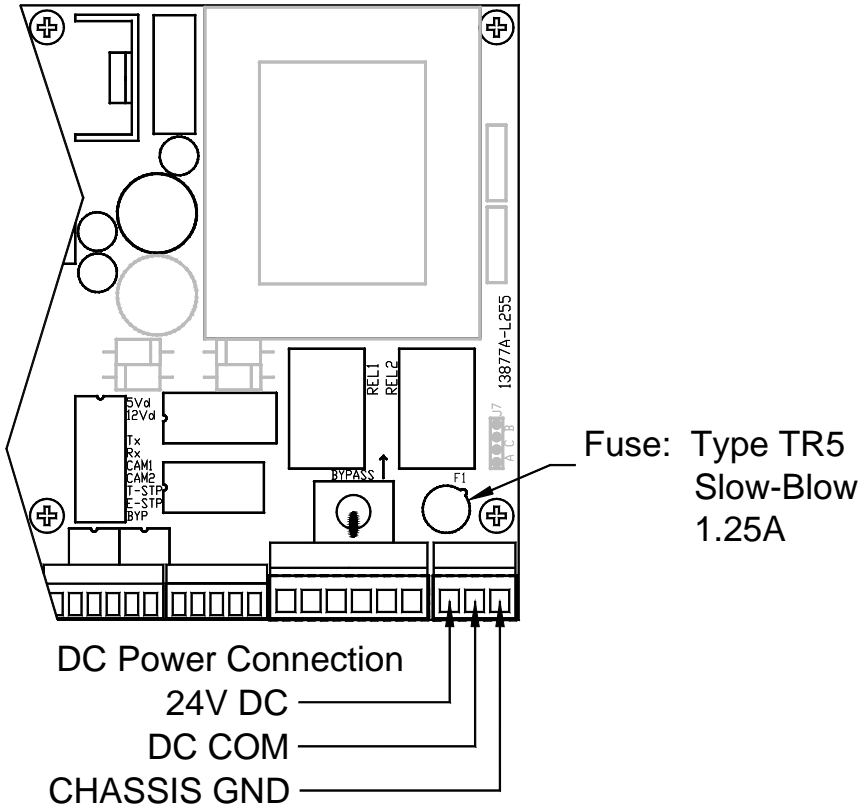
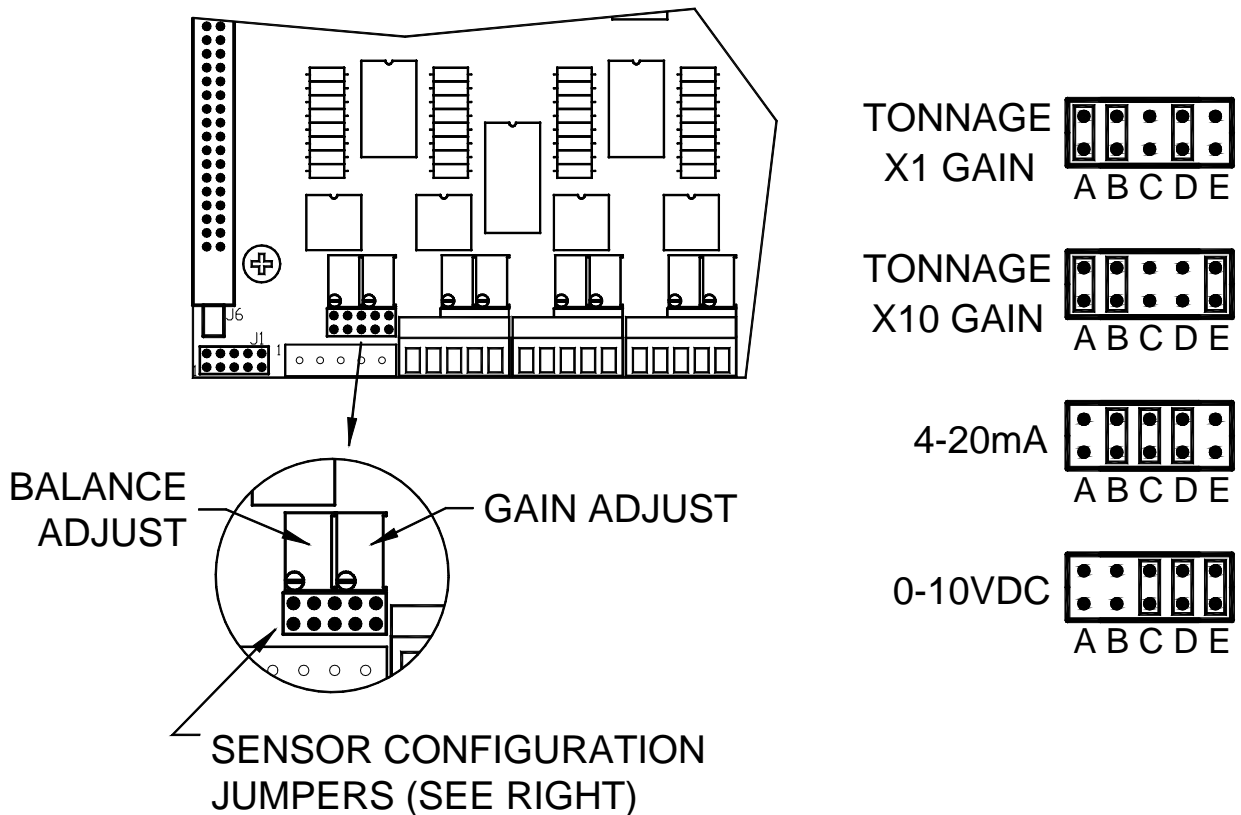

**Figure 1.6: DC Power Connection**



## Sensor Input Configuration

Each channel input on the PWi Forging Analog Board can be configured to accept a signal from a strain gage sensor, a 4-20 mA signal, or a 0-10 VDC signal. Balance and gain adjustments are made via two potentiometers for each channel. When configured for tonnage sensor input, gain ranges of X1 and X10 are also selectable. Refer to the illustration below for the location of the balance and gain adjustments and available sensor input configurations.

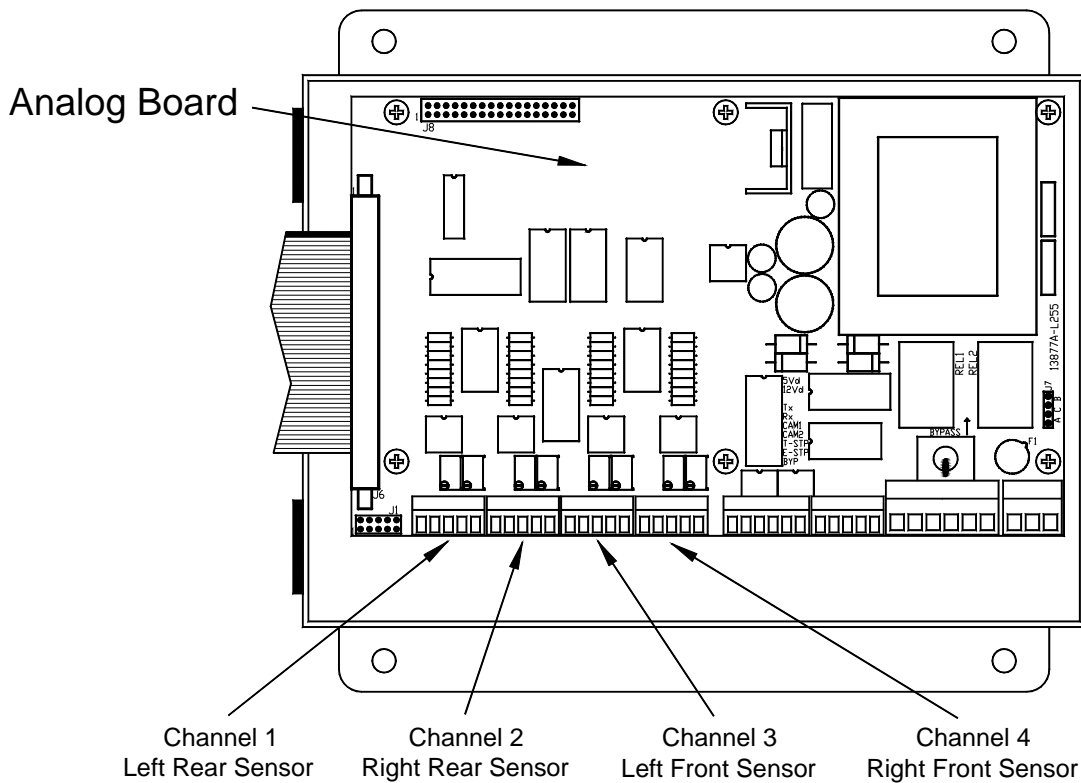

**Figure 1.7: Sensor Configuration Jumper Settings**

## Load Sensor Connection

Refer to Figure 1.8 for the procedures below to connect tonnage sensors properly:

- 1) Power down the unit. Open the door of the PWi Forging enclosure.
- 2) Run Load Sensor cables through Conduit Hole #1 (see Figure 1.4), and route cables upward to the Analog Board.
- 3) Prepare the sensor cable for termination as described on page 17.
- 4) Remove the four 5-pin Phoenix plugs from the analog board and wire each sensor cable as described on page 18.
- 5) The 5-pin phoenix plugs can then be inserted into the corresponding sockets. The load sensor cable connections are now complete.



**Figure 1.8: Sensor Input Locations**

## Sensor Cable Termination

- 1) Strip the sensor cable as shown in the figure below. Be sure not to nick any of the signal conductors or cut the braid shield.

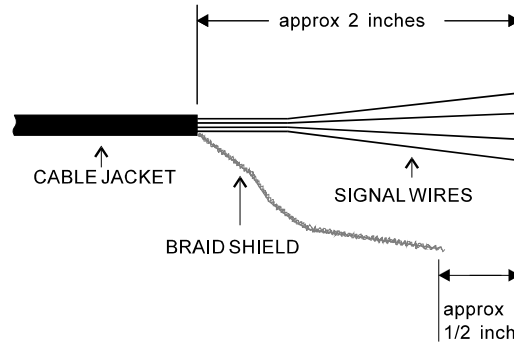

**Figure 1.9: Sensor Cable Stripping**

- 2) Strip approximately  $\frac{1}{4}$ " of insulation from each of the four signal conductors.
- 3) Trim braid shield so that it is  $\frac{1}{4}$ " to  $\frac{1}{2}$ " shorter than the signal wires.

**Note:** If your sensor cable is not double shielded with both foil and a braid, electrical noise may affect your output readings.

### Sensors Connection

The PWi Forging accepts the signals from Toledo Transducers T-400 sensors as well as other strain gage sensors. Figure 1.10 illustrates the sensor connections.

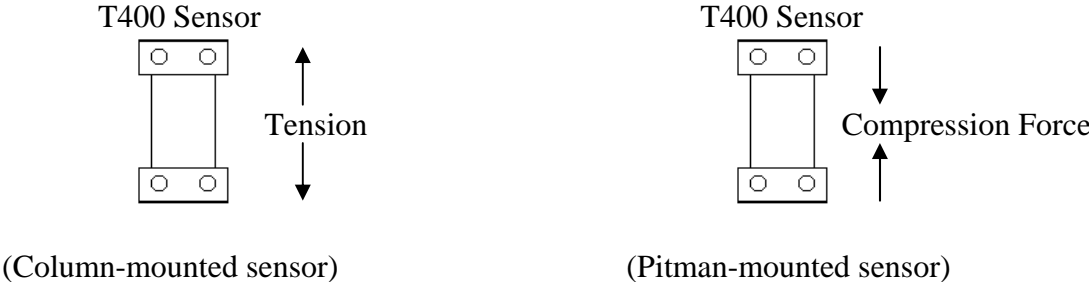

Tension connection shown.  
For compression connections,  
switch the red and white  
wires. Make sure the shield  
braid does not contact the  
signal wire terminals.

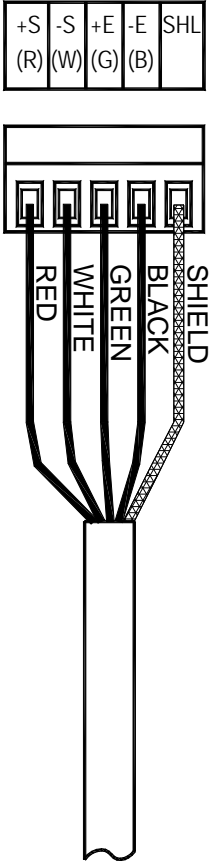

**Figure 1.10: Sensor Wiring**

## Analog Output

The analog outputs are provided on a 9-pin connector for easy access and for interfacing with other peripherals.

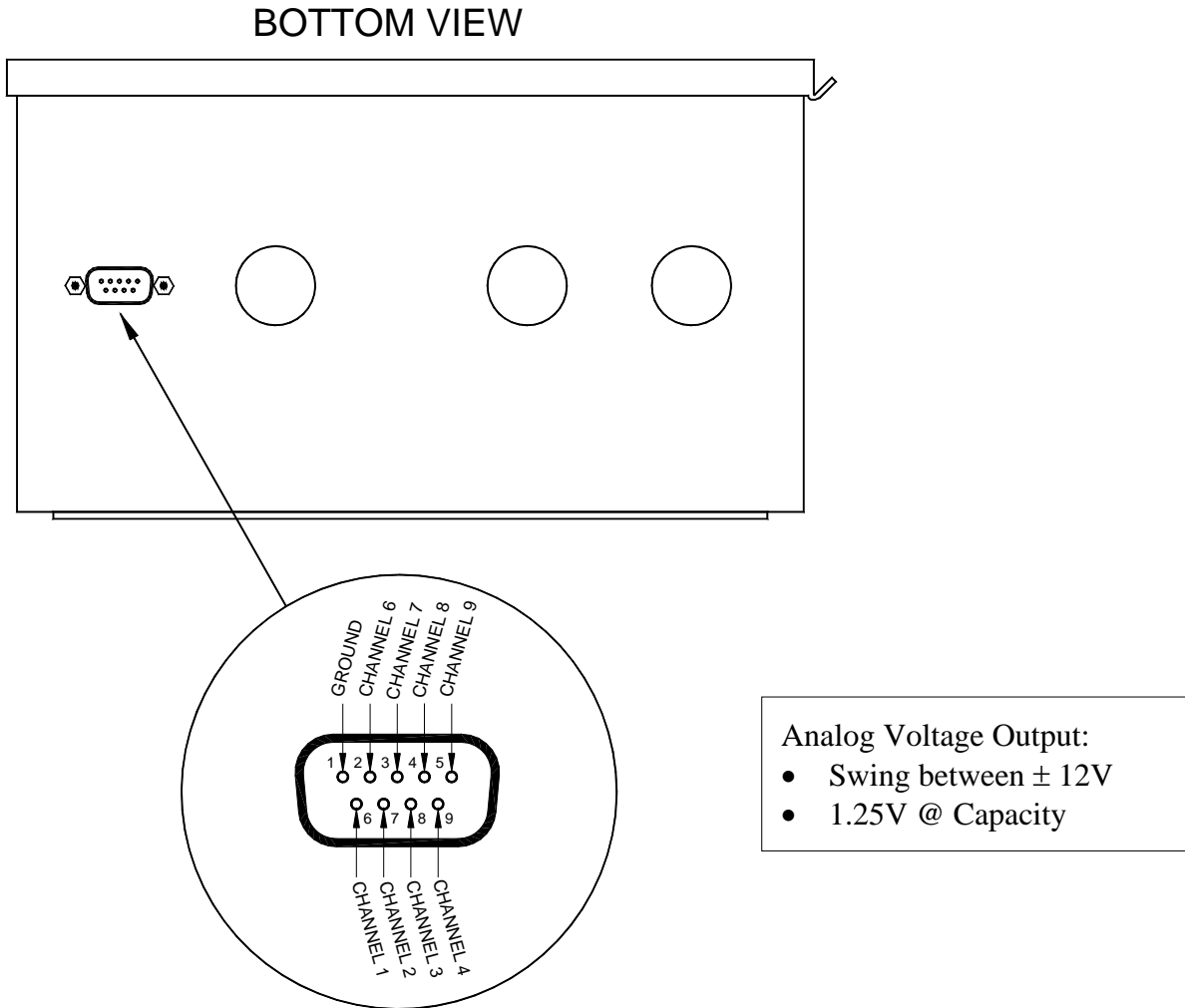

# Probe Input

The probe supply voltage (+12VDC) is supplied by the PWi Forging on the Vo terminal. The figure below shows the probe input location on the Analog Board and illustrates different wiring possibilities. Use Conduit Hole #2 (see Figure 1.4) to run the probe wiring. After wiring is completed, you must configure the unit for Probe triggering (see Page 54).

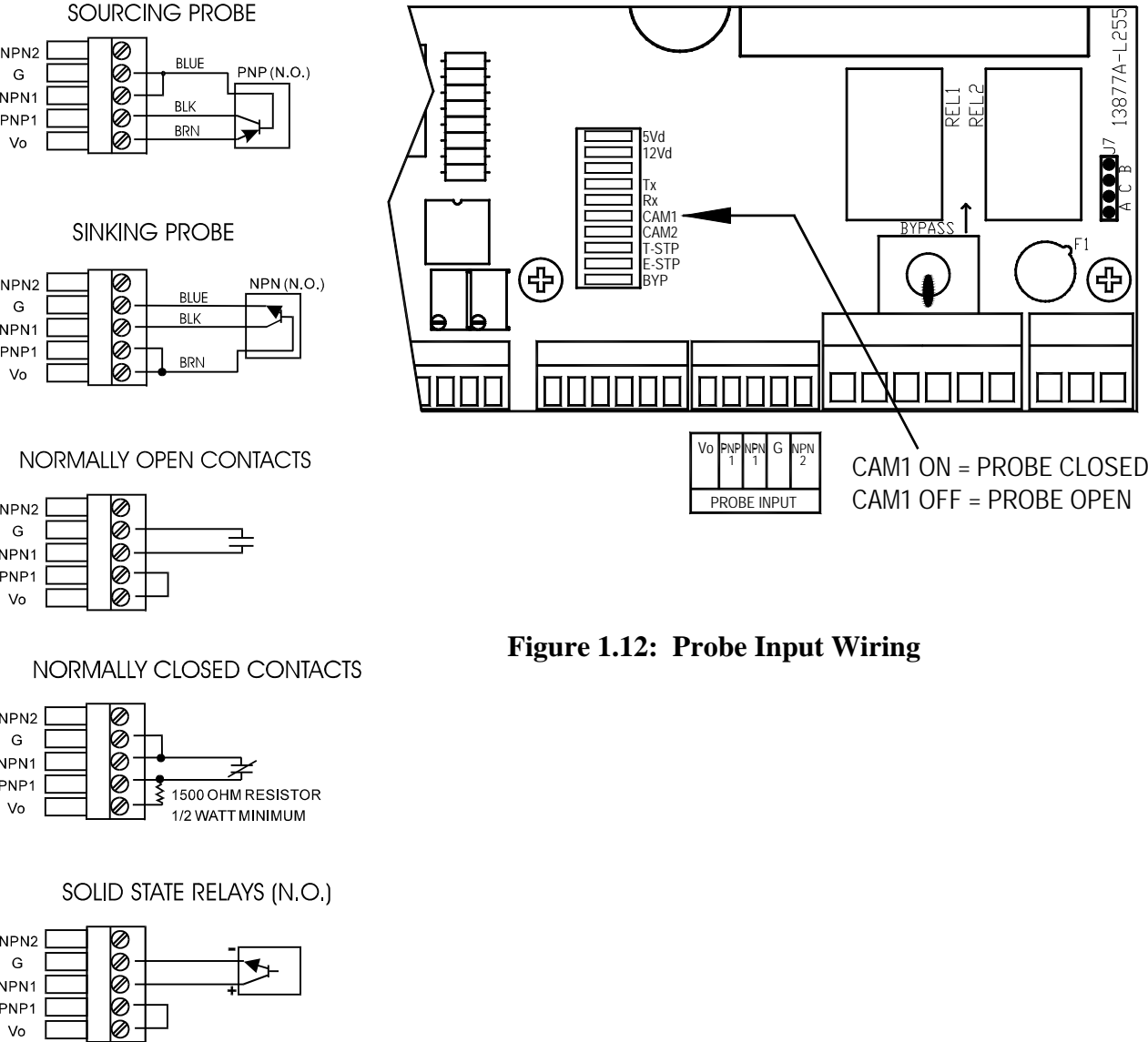
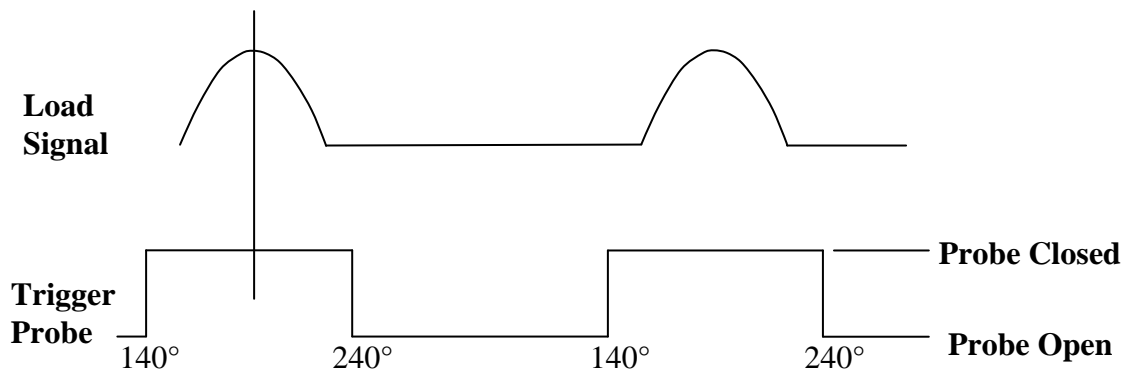

Figure 1.12: Probe Input Wiring

The timing of the probe should be such that it turns on just before the machine begins generating a load, typically at (140°) and remains on until the load is removed, typically at (240°).



**Figure 1.13: Probe Timing**

## External Reset Switch Connection

Two terminals are provided for connecting an external reset switch. The rating of the switch and wiring can be minimal because they interface with a small signal. Use Conduit Hole #2 (see Figure 1.4) to run the wiring for the reset switch.

NOTE – In order to reduce noise that may trigger false reset:

- Use twisted pair wires for the connection.
- Do not run this pair of wires along with any high voltage or high current cables.
- Keep the wiring no longer than 12 feet.

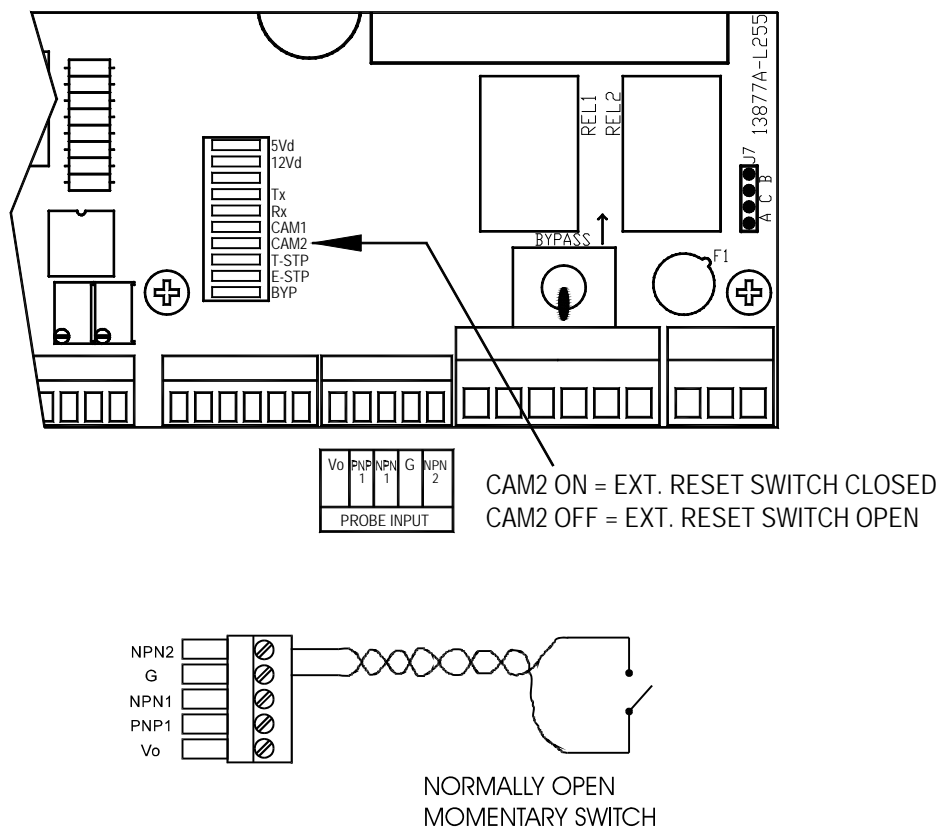

**Figure 1.14: External Reset Switch Wiring**



## Serial Port Connection

An RS422 serial port is available for interfacing the PWi Forging with a computer running the PressNet software. RS422 allows the implementation of a daisy chain (multi-drop) serial network as a standard feature.

The RS422-1 port can be configured for the following baud rates:

- 9600
- 38.4k
- 76.8k
- 115.2k

The figure below details the location of the RS422-1 port. Wiring diagrams can be found on the next page.

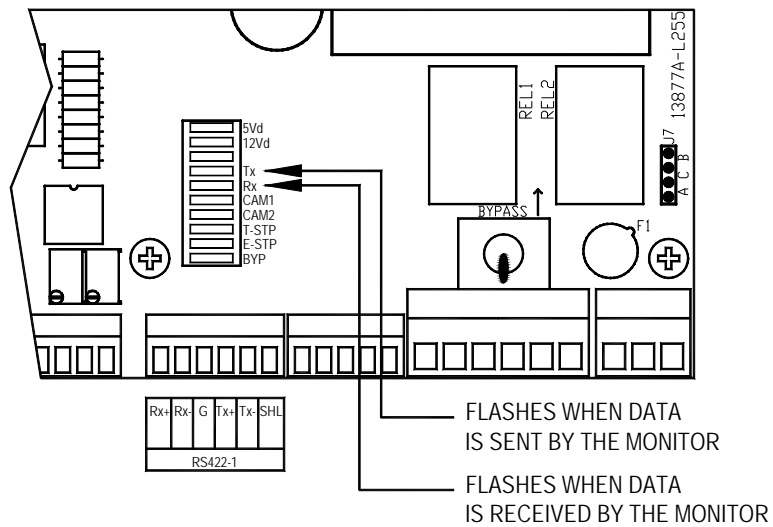

**Figure 1.15: Serial Connection**

**Computer to single PWi Forging monitor wiring:**

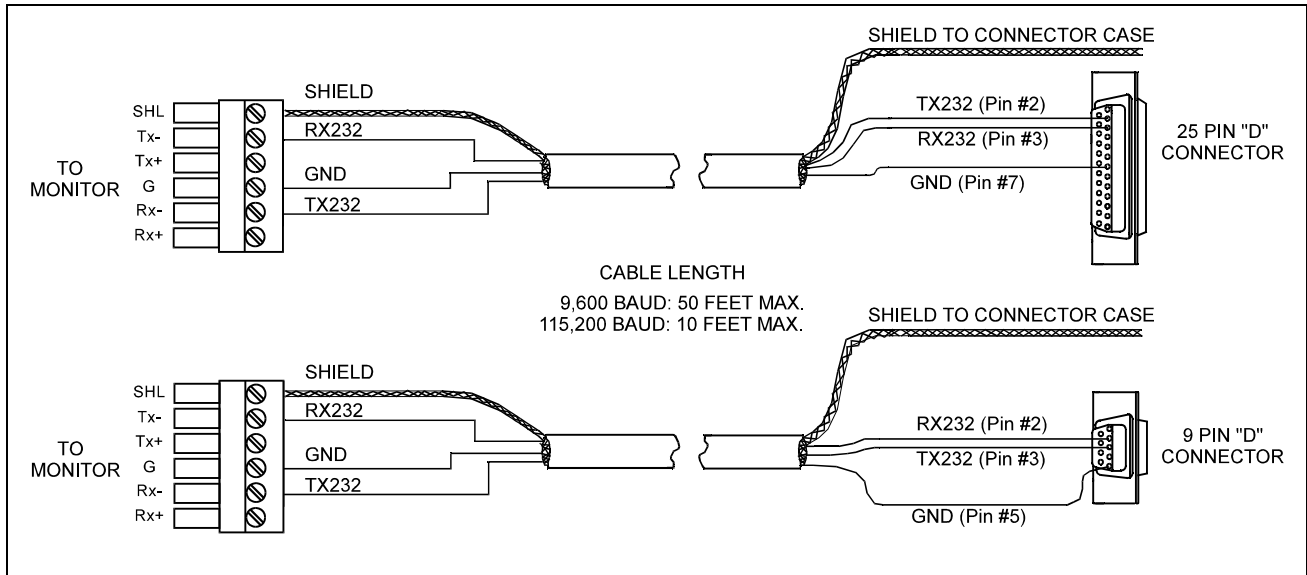

**Figure 1.16: RS232 Serial Port Wiring**

**Computer to multiple PWi Forging monitors wiring (Networking):**

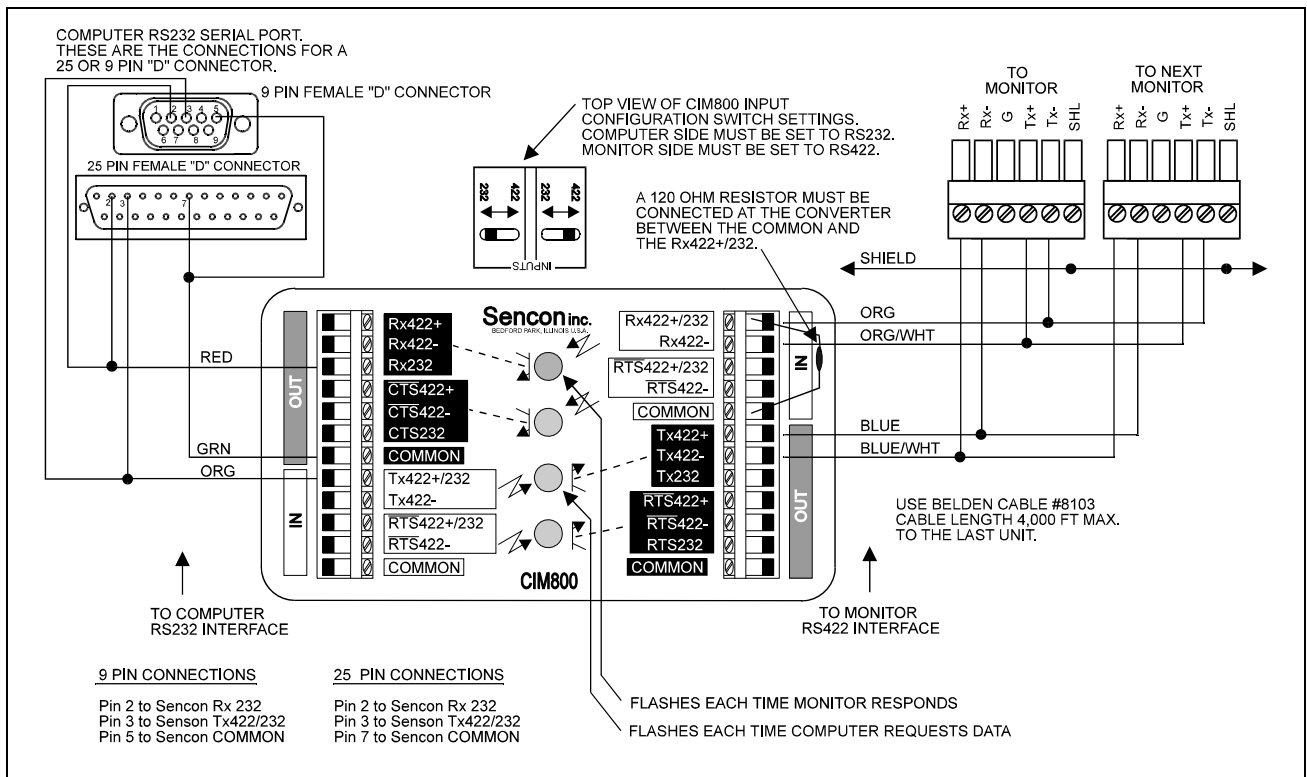

**Figure 1.17: RS422 Serial Network Wiring**

## Shutdown Relays

The PWi Forging provides a Top Stop Relay and an E-Stop (Emergency Stop) Relay. When enabled, the E-Stop Relay is used to stop the press immediately in case of a capacity violation. Each relay provides both Normally Open (N.O.) and Normally Close (N.C.) contacts. A toggle switch is provided to manually bypass the shutdown relays, if necessary.

### **\*\*CAUTION\*\***

**Bypassing the shutdown relays is a potentially dangerous situation. The monitor will not shut down the press when this switch is in the bypass position. Equipment can be damaged and personnel may be seriously injured without shut down protection.**

Use Conduit Hole #3 (see Figure 1.4) for the Shutdown Relay Wiring.

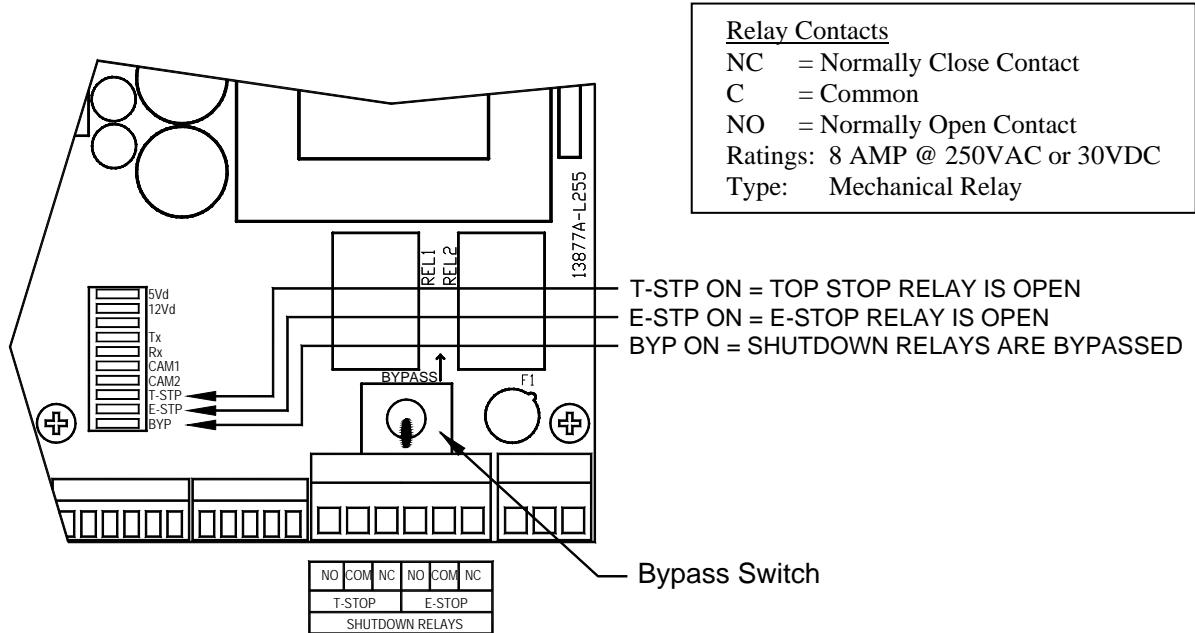

**Figure 1.18: Shutdown Relay Wiring**

### Shutdown Relay Terminals

T-Stop = For use in the Press Top Stop circuitry.

E-Stop = For use in the Press Emergency Stop circuitry.

Note that using the E-Stop under heavy loads may result in the ram becoming locked at the bottom.

Refer to the Configuration Menu section for instructions on enabling the E-Stop relay.





# 2: Operation

## User Interface

The PWi Forging is equipped with an easy to use menu-driven user interface. The six push buttons are used to view and change parameters. The following describes the layout of the LCD screen and the push buttons.

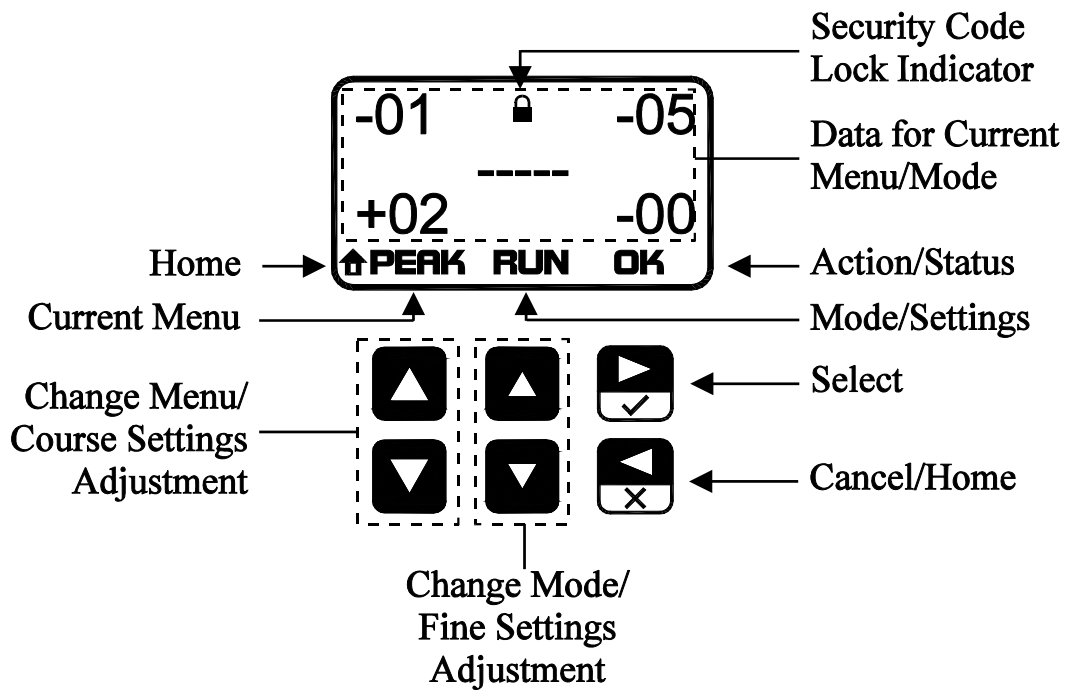

## Operation Mode and Configuration Mode

The “Operation Mode” is used in normal operation, and the “Configuration Mode” is for initial setup. Dip-Switch 1 in SW1 is used to select these modes. SW1 is located on the side of the Control Board which is mounted on the inside of the door.

### **To select the Operation Mode**

Set Dip-Switch 1 to up position

### **To select the Configuration Mode**

Set Dip-Switch 1 to down position

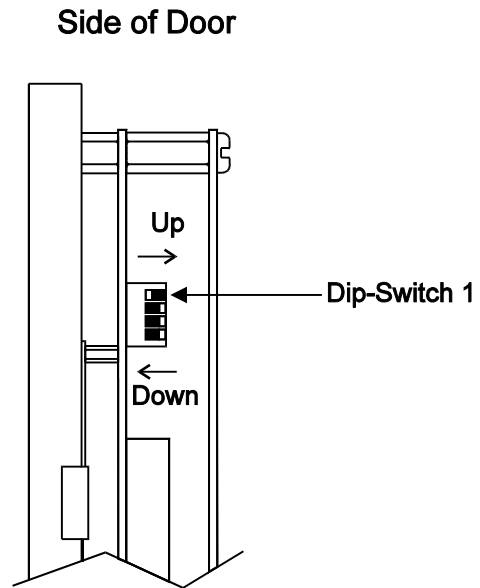

## The Security Code Feature

When it is enabled, the security code feature restricts unauthorized personnel from making changes while in the Operation mode. It requires the entry of a 4-digit code before performing the following functions:

- Changing the mode (Run/Setup/Learn)
- Changing setpoints (High, Low, and Reverse)
- Resetting tonnage alarms
- Clearing statistics
- Changing jobs

As a reminder of the current security status, a lock indicator appears at the top of the LCD display when a security code has not been entered.

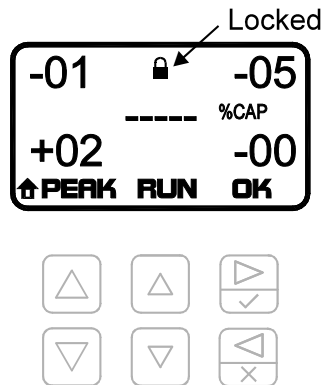

To manage the security code functions, there is a Security Code menu on both the Operation mode and the Configuration mode. Each Security Code menu has different functions.

### Security Code menu functions for the Operation mode:

- Locking and unlocking the security code.

### Security Code menu functions for the Configuration mode:

- Enabling and disabling the security code feature.
- Changing the 4-digit security code.
- Resetting the security code to its default.

Refer to the Operation mode and Configuration mode sections for more details.

## The Low Battery Indicator

All critical settings, including system configuration (Capacities, threshold, etc.) and job-related setpoints are stored in nonvolatile flash memory to prevent data loss. However, some non-critical information, including alarm counts, statistics, and live load values, are stored in battery-backed memory.

When the battery's voltage becomes low, a low battery indicator appears on the LCD display on the Home menu.

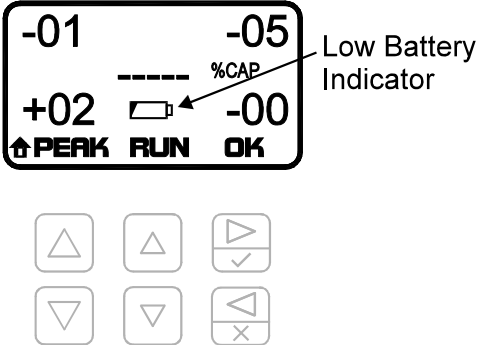



## **Replacing the Backup Battery**

The backup battery is a 3V Lithium, type CR-1/3N and is commonly sold at most electronics retailers, including RadioShack®. It is located on the Control Board, which is mounted on the inside of the unit's door.

To replace the battery:

- 1) Remove power from the PWi Forging unit.
- 2) Open the enclosure door and locate the Control Board. It is the board mounted on the door.
- 3) Remove the (6) screws that secure the cover plate to the Control Board. Place the screws and the cover plate aside.
- 4) Locate the battery. Refer to the following diagram.

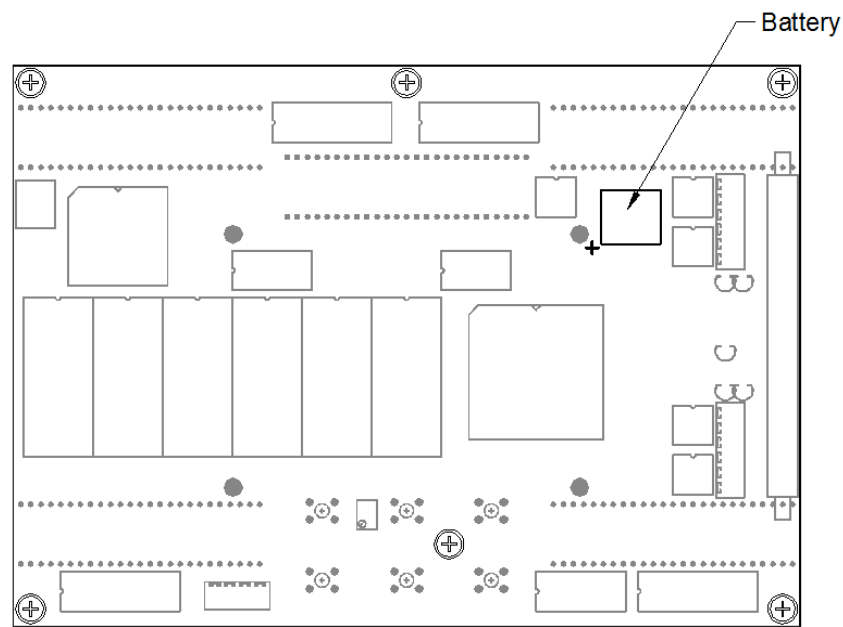

PWi Forging Control Board

- 5) Remove the old battery from its socket.
- 6) Insert the new battery. Note the battery polarity printed on the circuit board.
- 7) Reinstall the cover plate using the (6) screws that were removed in step 3.
- 8) Close the enclosure door.
- 9) Apply power.

## Operation Mode - Overview

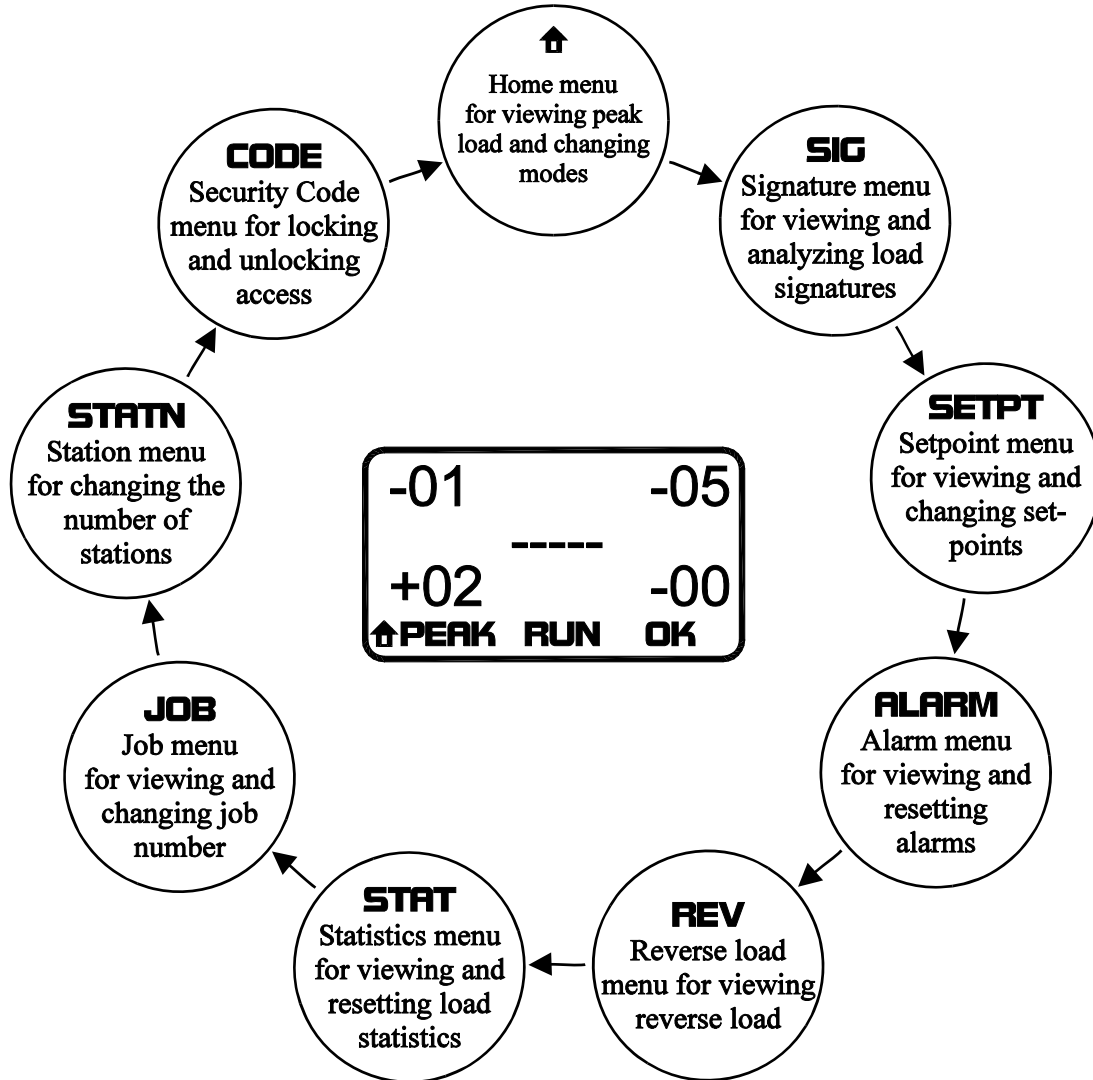

### To view other menus

Push or until the desired menu is shown.

### To return to the Home menu

From any menu, push to return to the Home menu. The home symbol on the bottom left corner of the display indicates that the current menu is home.



## Operation Mode - Description

### Home Menu

- The Home menu displays the current peak load and the variation from the benchmark load, as well as the current station number. Setup and Learn mode can be enabled from this menu and the alarm and bypass status can be viewed. If the unit is configured for resolver triggering, the position is displayed here, as well.

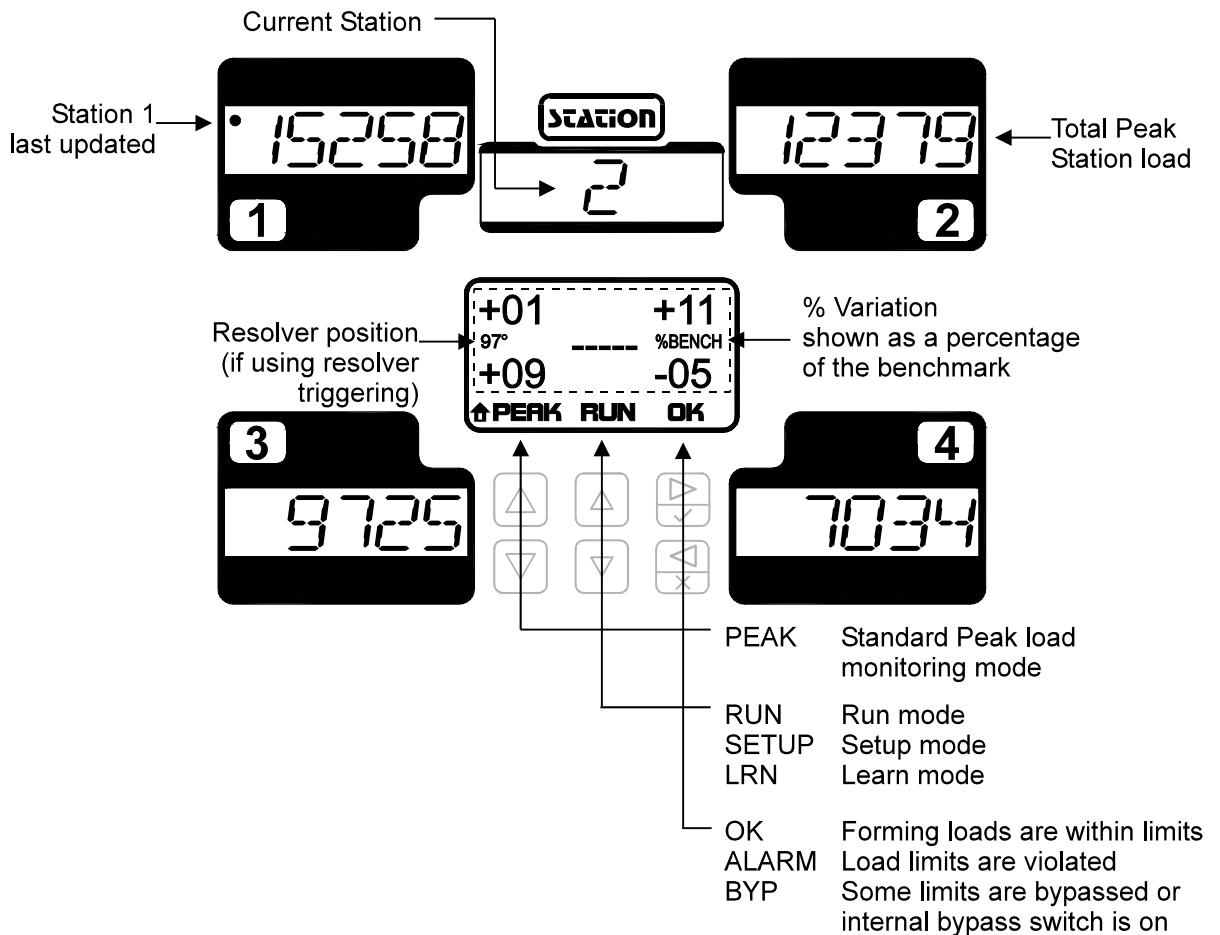

### About the displays





The (4) outer 7-Segment displays show the total peak load for stations 1-4. As the press cycles and the peak values update, the last station indicator (a dot in the upper left corner of the display) moves to the last station in the sequence that was updated. The center 7-Segment display shows the current/next forming station in the sequence. The LCD screen in the center shows the % variation of the current peak load from the learned benchmark load. Each % variation value on the LCD corresponds to one of the stations. For example, the upper-left % variation value corresponds to station 1, the upper-right value corresponds to station 2, etc.

### About the operating modes

The operating mode determines how the monitor reacts to the load.

- **Run mode** is used for production. All setpoint alarms are active in Run mode.
- **Setup mode** is used for die setup. Only capacity limits are active in Setup mode.
- **Learn mode** is used to teach the monitor new alarm setpoints. After the unit is placed in Learn mode, the next cycle through the stations is used to generate a new benchmark and new high and low setpoints. The monitor then switches to Run mode to continue production.

### To change the operating mode

- 1) Push  or  until the desired mode (RUN, SETUP or LRN) is shown.
- 2) Push  to accept the change, or push  to cancel the change.

**Note:** When Setup mode is enabled, the capacity is displayed in place of the % variation. This is a reminder that only capacity limits are active in Setup mode.

### Notes:

- The figure above illustrates a four-station configuration. If less than four stations are configured, the unused stations will remain blank.
- The number of stations required can be changed from the Station Menu, which is covered later in this section.



## Signature Menu



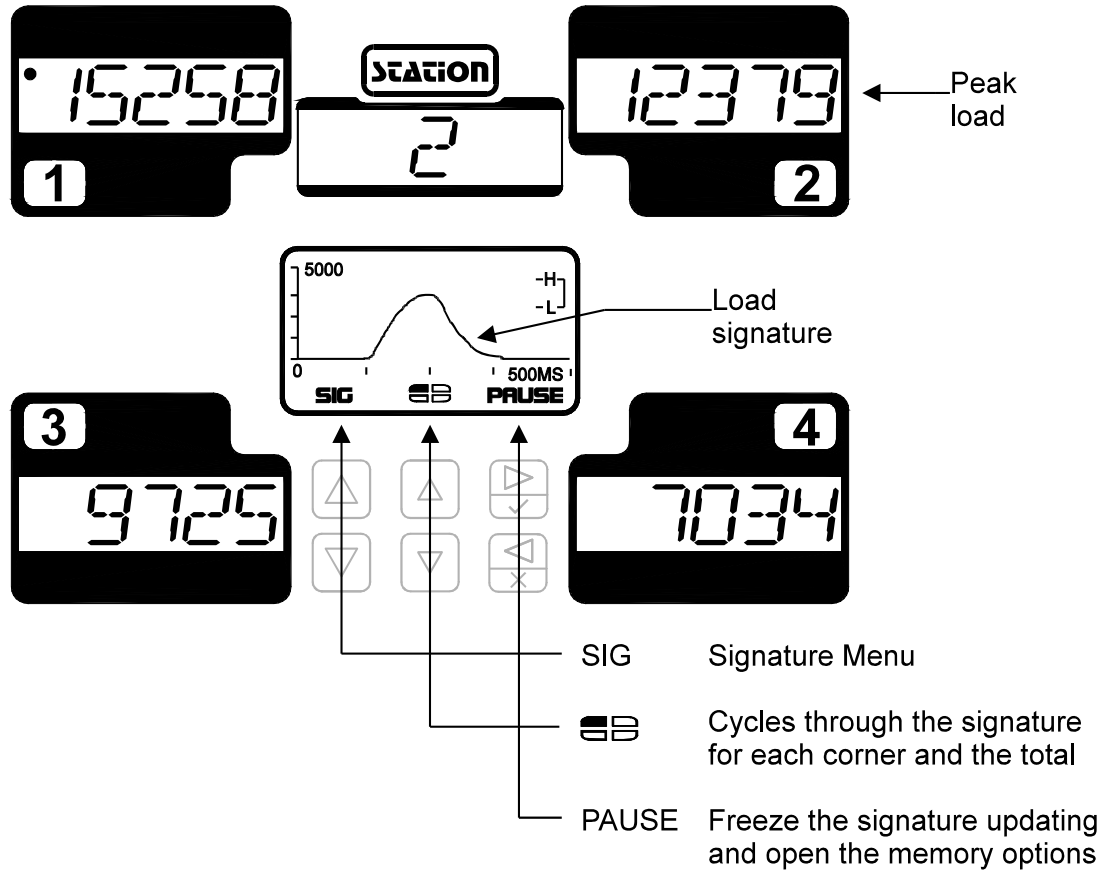

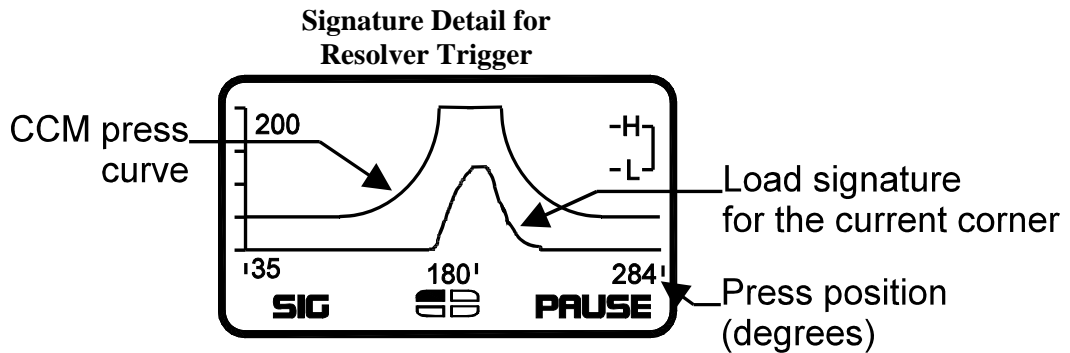
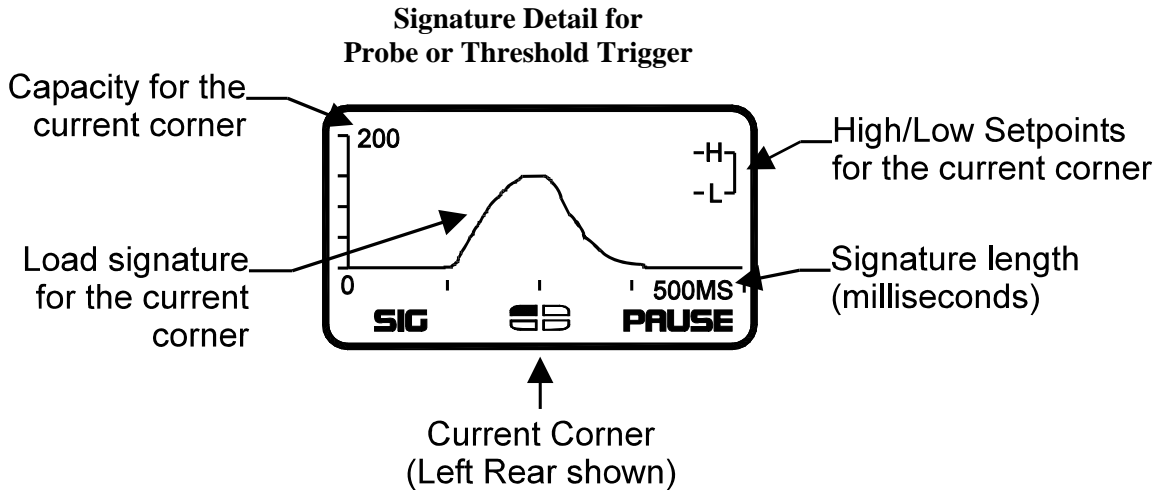
- The Signature menu displays the load signature for the current stroke for analysis and troubleshooting purposes.





**To view each corner's signature**



The corners are represented graphically by four quadrants on the signature menu which correspond to the press corners. For example, in the signature detail above, the upper-left quadrant is filled in while the remaining three quadrants are empty. This indicates that the Left Rear corner is currently displayed. If all four quadrants are filled in, the Total is currently displayed. To select other corners:

- 1) If the signature is not paused, push  or  until the desired corner is shown.
- 2) If the signature is paused, push  or  until the desired corner is shown.

As each corner is selected, the quadrant symbols on the menu will change to indicate the current corner.

### To pause and resume the signature updating

- 1) While the right menu is showing PAUSE:

Push  to stop the signature updating. The right menu now changes to BACK. In this state, the press can continue to run but the signatures will not update. Also, notice that the corner selection menu option has shifted from the center menu to the left menu position. While the signature is paused, the  and  buttons are used to cycle through each of the corners.

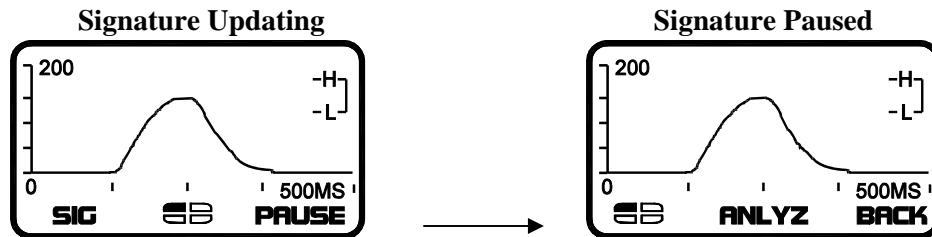

- 2) While the right menu is showing BACK:

Push  again to resume the signature updating.





### To save and load signatures

- 1) While the signature is paused and the center menu is showing ANLYZ:

Push  or  to access the signature analysis tools. The center menu is now selected and the right menu now changes to APPY.



With the center menu showing MEM, push  to access the various memory options.

- 2) To save the current signature:

Push  or  to cycle through the memory options until SAVE1 or SAVE2 is selected.



Push  to save the current signature to the corresponding memory location.



- 3) To load a previously saved signature:

Push  or  to cycle through the memory options until LOAD1 or LOAD2 is selected.

Push  to load the signature.

While the signature is being viewed, the current signature number is shown at the top left corner of the display and the following options are available:



Push  or  to cycle through the corners, or

Push  or  to select the Cursor tool for point-by-point analysis, or

Push  to close the signature and resume signature updating.



**To analyze a signature using the Cursor tool**

- 1) While the signature is paused and the center menu is showing ANLYZ:



Push  or  to access the signature analysis tools. The center menu is now selected and the right menu now changes to APPY.

With the center menu showing CUR, push  to turn on the Cursor tool.

- 2) To view load signature details when using probe or threshold triggering:

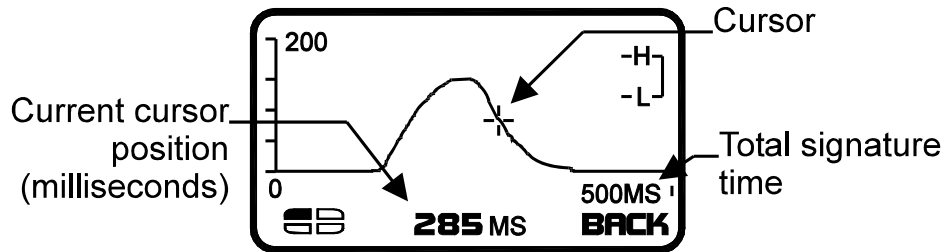

Push  or  to increase the time value in the center menu and move the cursor along the load signature. As the cursor moves, the corner displays update with the load for the selected point on the curve.





Push  or  to cycle through the corners, or

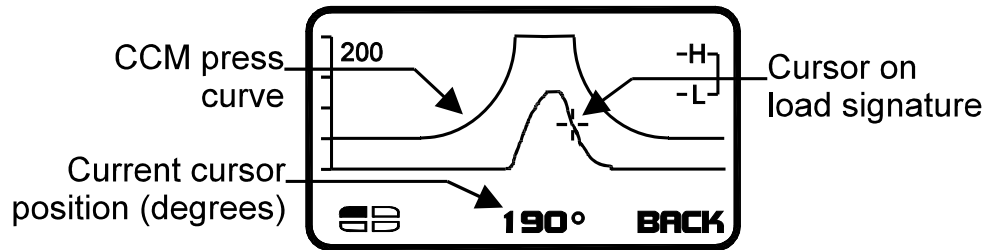

Push  to close the signature and resume signature updating.

- 3) To view load signature details when using resolver triggering:

Push  or  to increase the press angle value in the center menu and move the cursor along the load signature. As the cursor moves, the corner displays update with the load for the selected point on the curve.



Push  to toggle the cursor between the load signature and the CCM press curve. When the cursor is on the CCM press curve, the corner displays provide the load for the press curve at the selected position.

Push  or  to cycle through the corners, or

Push  to close the signature and resume signature updating.







## Setpoint Menu

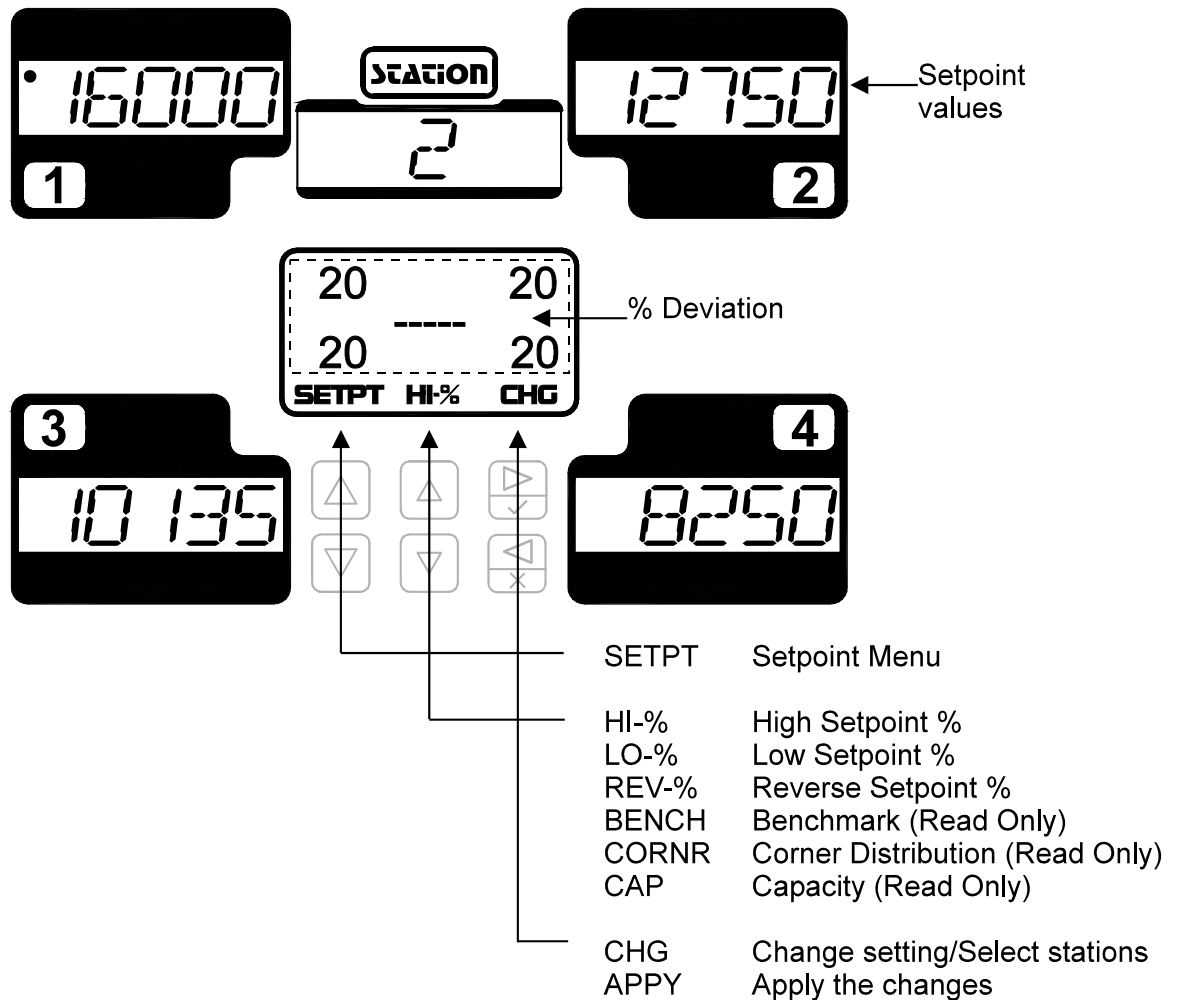







- The Setpoint menu displays information for the various types of setpoints and allows each station's setpoint value to be adjusted. Other information, such as Corner Tonnage Distribution, Capacity, and Benchmark values, can be viewed.



### To view setpoints

- 1) Push  or  until the desired setpoint is shown.
- 2) Setpoint values are shown in the associated stations.



**To change setpoints**

- 1) Push  to enter change mode. Station 1 is then selected.
- 2) Push  to select the desired station.
- 3) Push  or  to change the value, or  
Push  or  to change in a larger increment.
- 4) Push  to accept the change (the next station will be selected), or push  to cancel the change.
- 5) Repeat from Step 2 to make changes on other stations.
- 6) Push  to exit change mode.

**Note:**

To bypass a station's setpoint, change the station's setpoint % to zero. For example, to disable reverse alarms for station 4, change the REV-% for station 4 to zero.

**To view corner tonnage distribution**

- 1) Push  or  until the center menu shows **CORNR**.
- 2) The peak tonnage values for each channel are shown in the associated corners of the LCD, with the total displayed in the center.

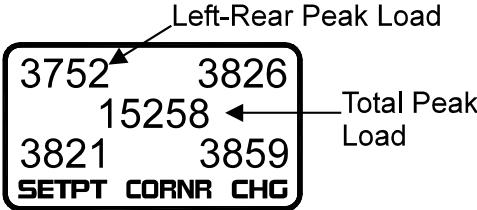

## Alarm Menu

- The Alarm menu displays detailed alarm information for each of the stations. If there is an active alarm, it can be reset from this menu.

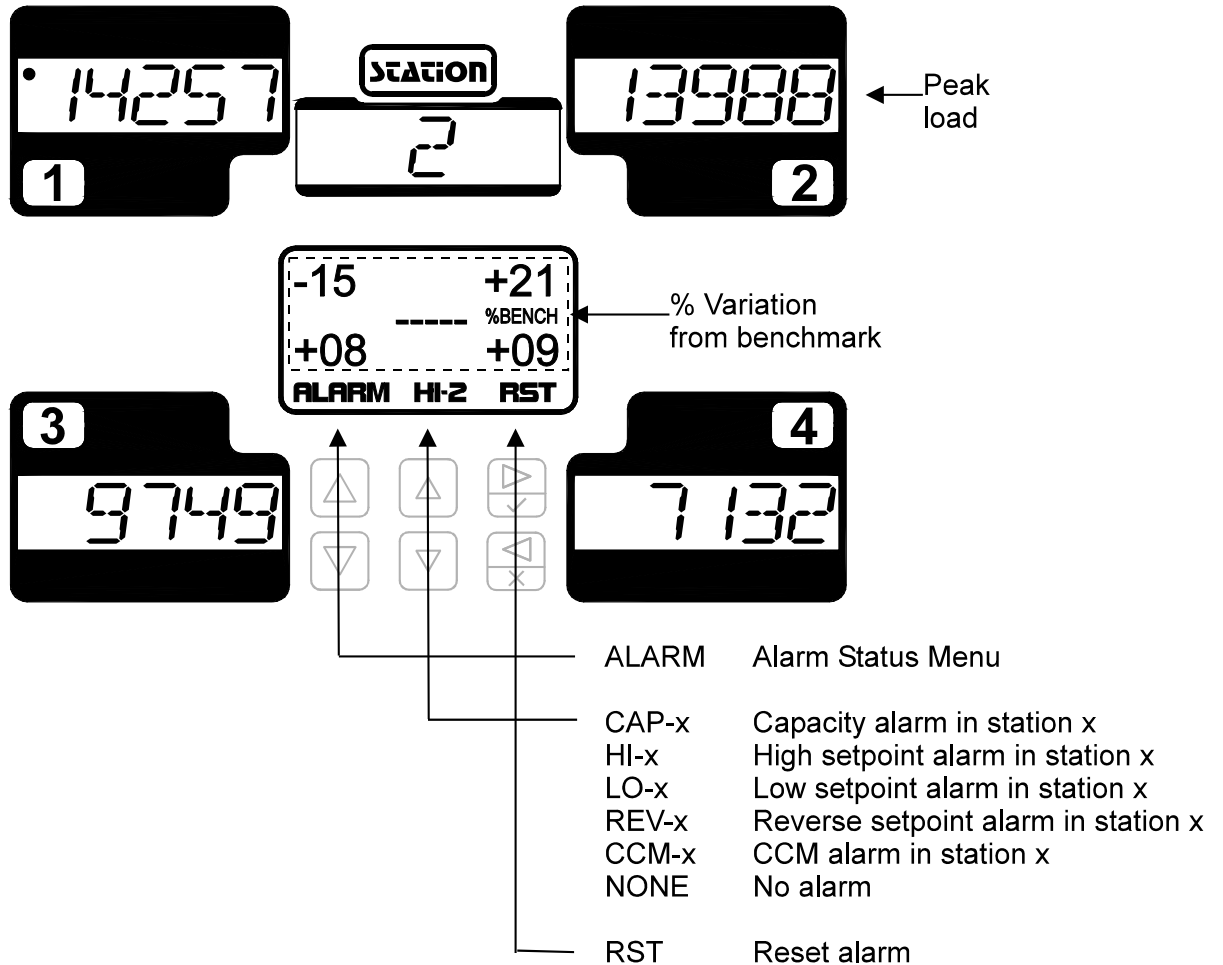

### To view the alarm list

Push or to see each alarm if more than one type of alarm has occurred. If an alarm is active, its associated station load value will flash.

### To reset an alarm

Push to reset all alarms.

### Notes:

- Resetting an alarm will automatically reset the station sequence.

**Reverse Menu**

- The Reverse menu displays the current reverse load data for each station.

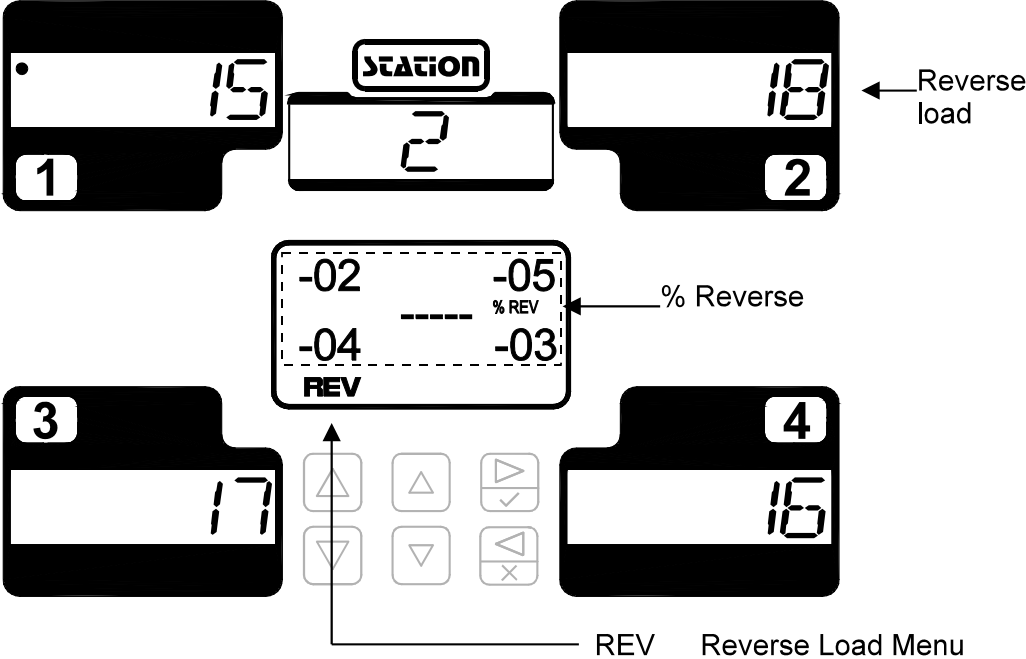

**To view Reverse Load**

Reverse load values are shown in the associated stations and the Reverse load as a percentage of capacity is shown on the LCD display.

## Statistics Menu



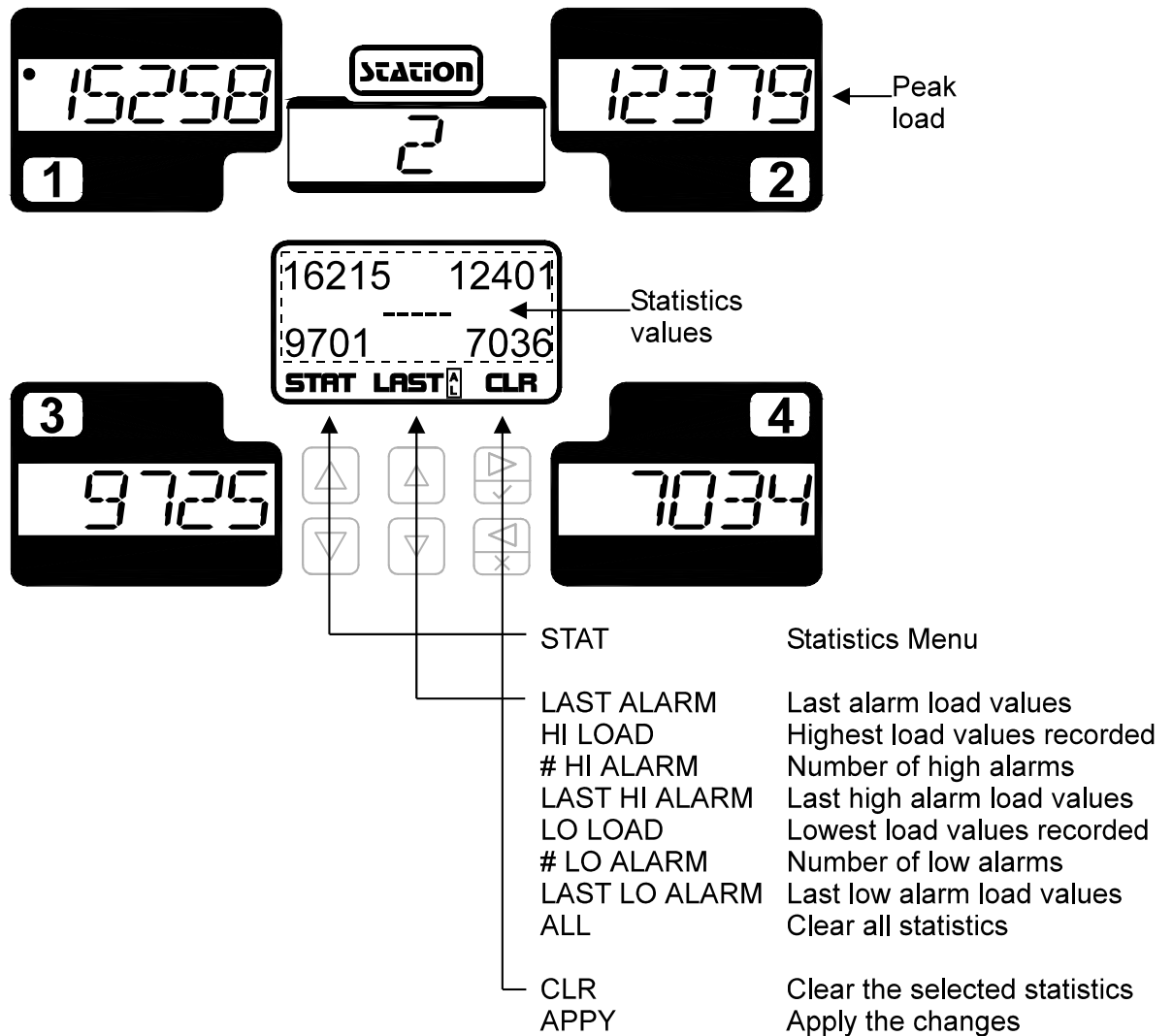

- The Statistics menu displays historical load information for the current job. Various data, such as last alarm, highest load, number of high alarms, etc., can be viewed and reset. The statistics are automatically reset when a job is loaded.







### To view statistics

- 1) Push or until the desired statistic is shown.
- 2) Statistics values are shown in the associated stations.

**To clear individual statistics**

- 1) Push  or  until the desired statistic is shown.
- 2) Push  to enter clear mode. All stations are then selected and the cleared statistics values for each station are shown.
- 3) Push  to accept the clear, or push  to cancel the clear.

**To clear all statistics**

- 1) Push  or  until "ALL" is shown.
- 2) Push  to enter clear mode. All stations are then selected and the cleared statistics values for each station are shown.
- 3) Push  to accept the clear, or push  to cancel the clear.





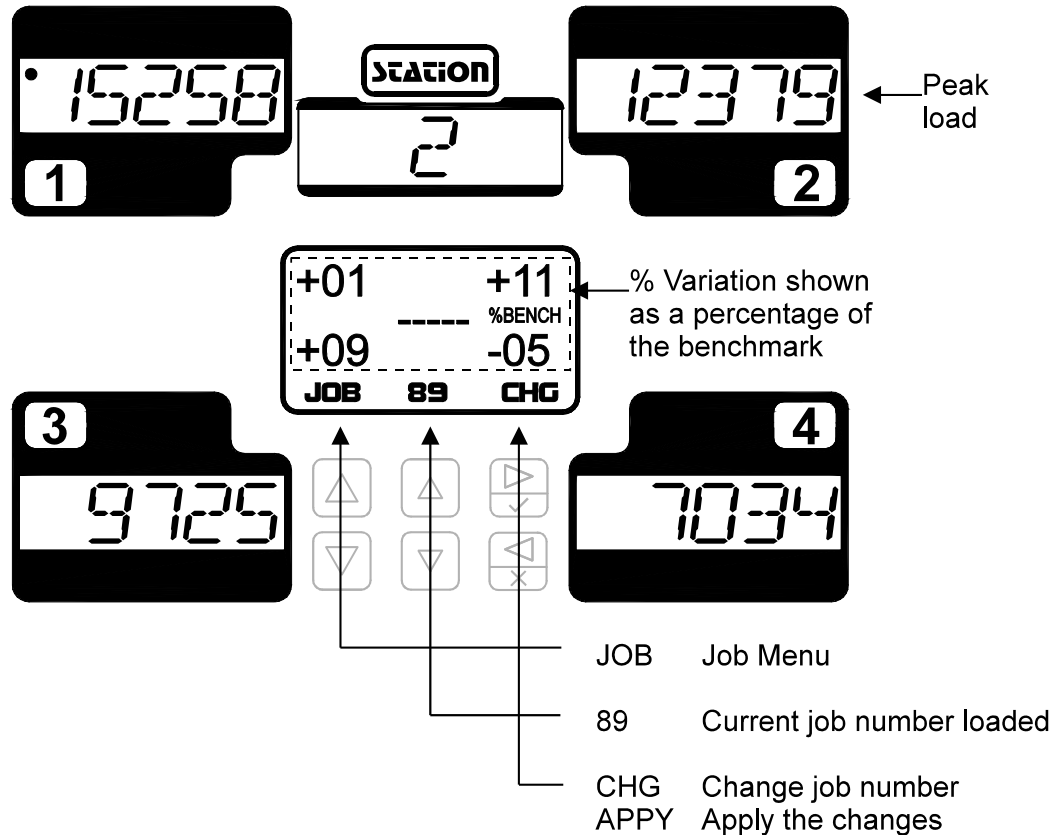

## Job Menu

- Jobs provide a convenient way to save and recall the settings associated with a particular part. Setpoints and benchmark data can be saved to a particular job number and recalled later when needed. The Job menu displays the active job number and allows the user to change to a previously created job or create a new job.



### To change the Job Number

- 1) Push  to enter change mode. Current job number is then selected.
- 2) Push  or  to change the setting.
- 3) Push  to accept the change, or push  to cancel the change.

### Notes:



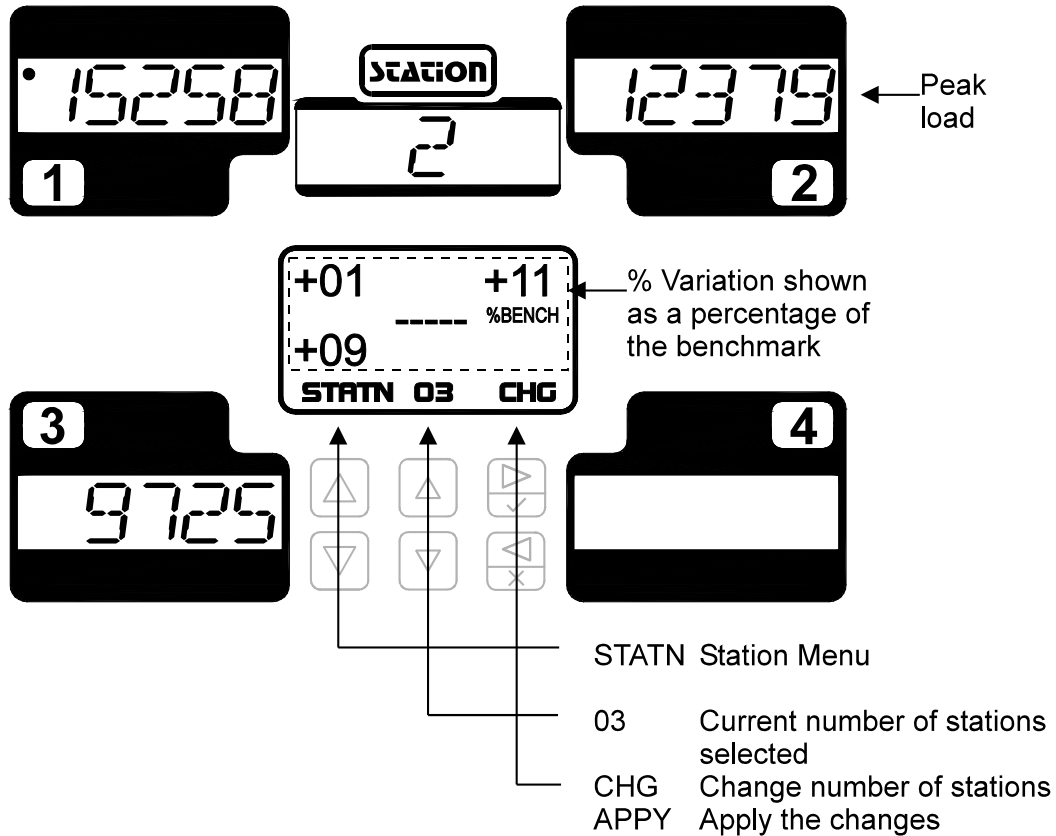

- Up to 100 jobs (0-99) can be stored and recalled.
- When a previously unused job number is selected, a new job is created. When this happens, the setpoints from Job #0 are used as a template.

## Station Menu

- The PWi Forging monitor supports up to four forming stations. If a job calls for less than this, the number of stations can be changed in the Station menu.



### To change the number of Stations displayed

- 1) Push  to enter change mode. Current number of stations is then selected.
- 2) Push  or  to change the setting.
- 3) Push  to accept the change, or push  to cancel the change.

### Notes:

- When less than four stations are selected, the displays for the unused stations will remain blank. For example, in the above illustration, station 4 is blank because the number of stations is set to 3.
- Setting the correct number of stations is important because this setting determines how many press strokes occur before the sequence restarts.







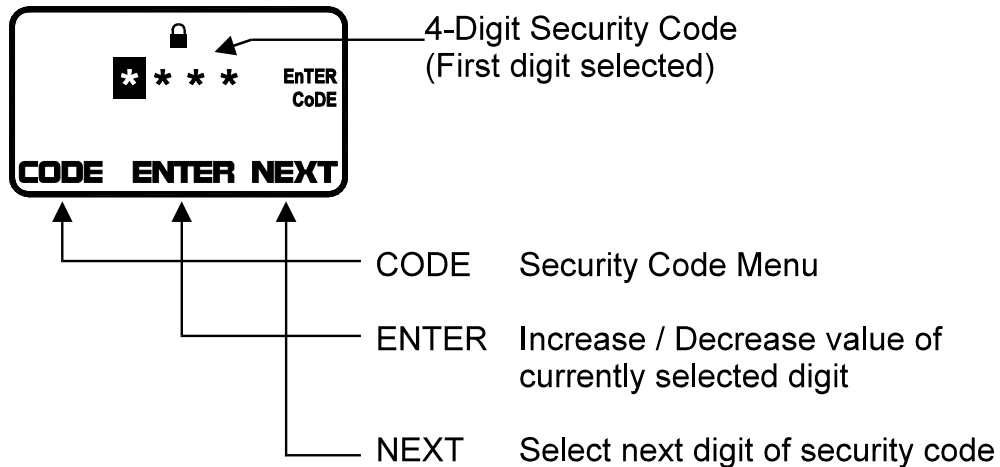

**Security Code Menu (Operation mode) (only available when the security code is enabled)**

- In the Operation mode, the Security Code screen is used to enter the 4-digit security code to unlock access to the protected features, and to lock the unit again after the desired changes are made.



**To enter the Security Code**

The security code consists of four numerical digits, each with a range of 0-9. For security reasons, the digits are not displayed on the LCD as they are entered. The digits are represented by “\*” with the currently selected digit highlighted. Digits are incremented and decremented with the middle arrow buttons,  or . The  button accepts the current digit and advances to the next digit.

- 1) Push  or  to increment or decrement the current digit.
- 2) Push  to accept the current digit and advance to the next digit.
- 3) Repeat steps 1 and 2 until all four digits have been entered.

If the security code is incorrect, the first digit will once again be highlighted. If the security code was accepted, the screen will return to the Home menu and lock indicator will be gone to indicate that all features are now unlocked.

**Note:** The default security code is **4-1-7-0**

The following example demonstrates the sequence to enter a security code.

**Sequence to Enter a Security Code**

**Example:**  
Entering a security code of 3-5-0-6...

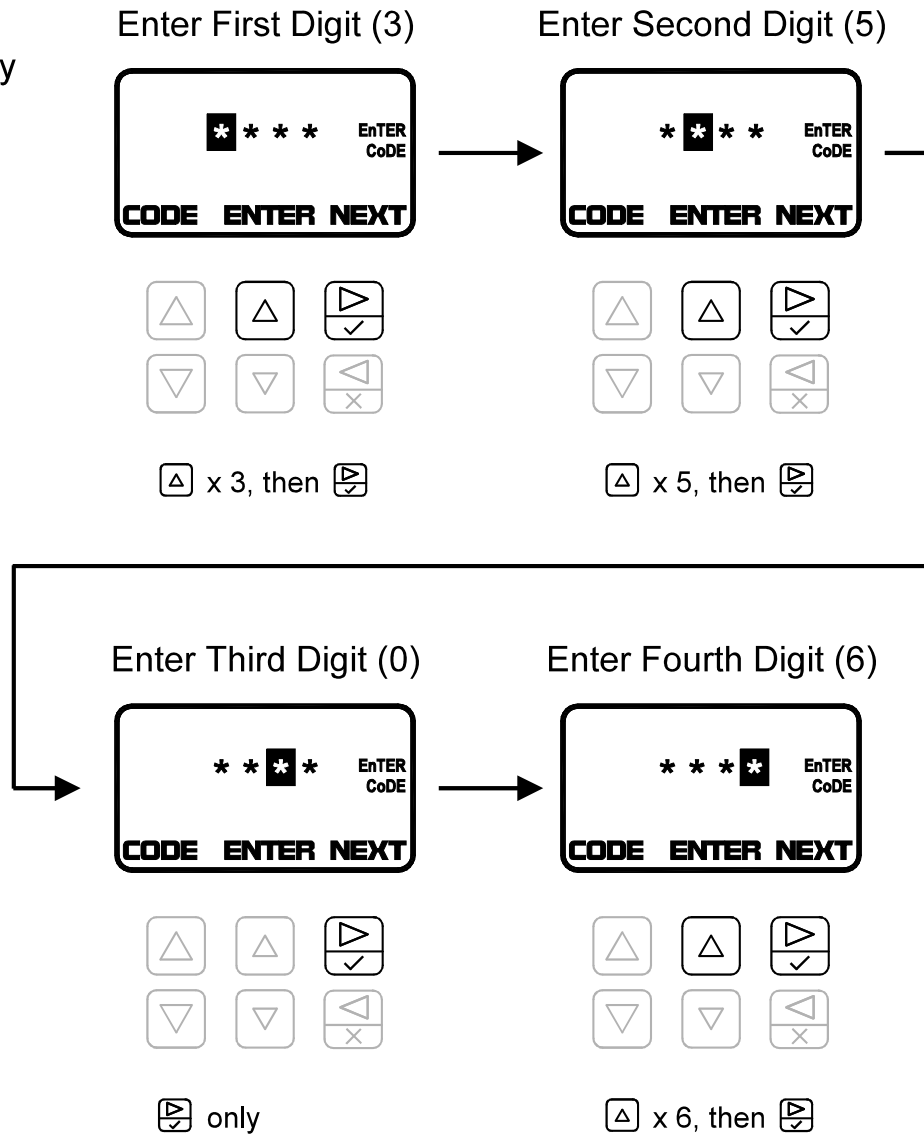



**Notes:**

- Highlighted digits start with a value of zero. To enter a zero, like the third digit in the above example, simply press without pressing any other button.
- Digits can be entered with either the or buttons. For example, the digit “9” can be entered by pressing nine times or by pressing one time.
- If you suspect that an incorrect digit was entered, you can press to cancel the code entry and start again at the first digit.

### To lock the Security Code

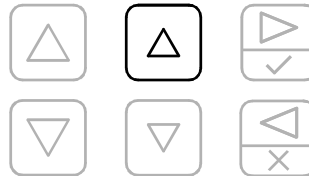
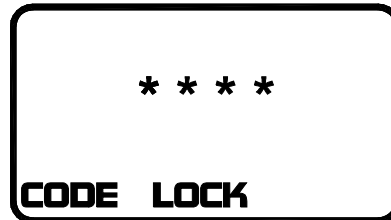
Once a valid security code has been entered, the lock indicator will disappear to indicate that the security code is unlocked. When the code is unlocked all settings and functions are active. After the desired changes have been made by authorized personnel, the security code should be locked again so that no further changes are made. This is done on the Security Code screen.



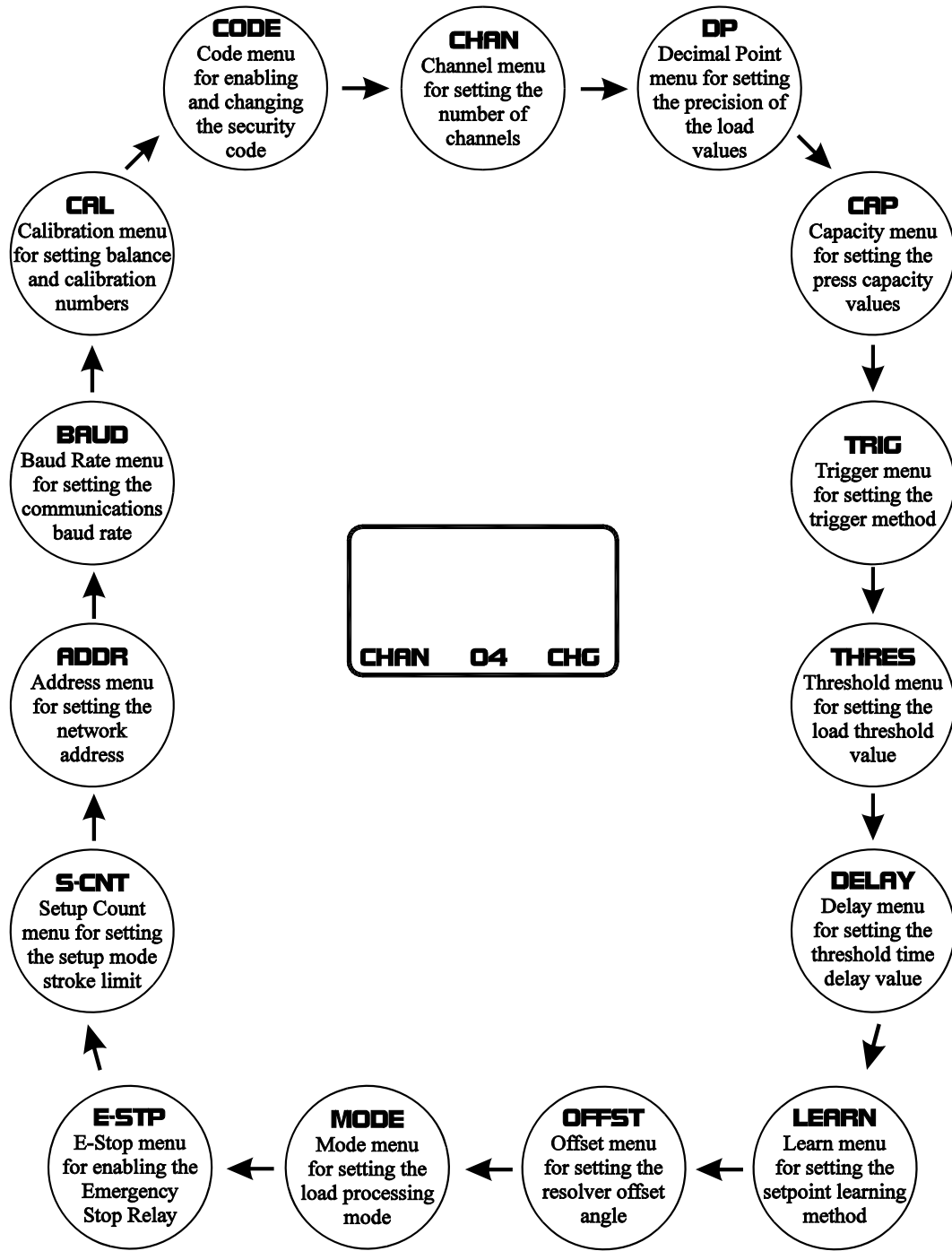

To lock the security code, press . The PWi Forging monitor will return to the Main screen and the lock indicator will reappear to indicate the security code is once again locked.

## Configuration Mode - Overview



### To view other menus

Push  or  until the desired menu is shown.

**Note:** Depending on the trigger method and mode selected, some menus will not be shown.

## Configuration Mode - Description



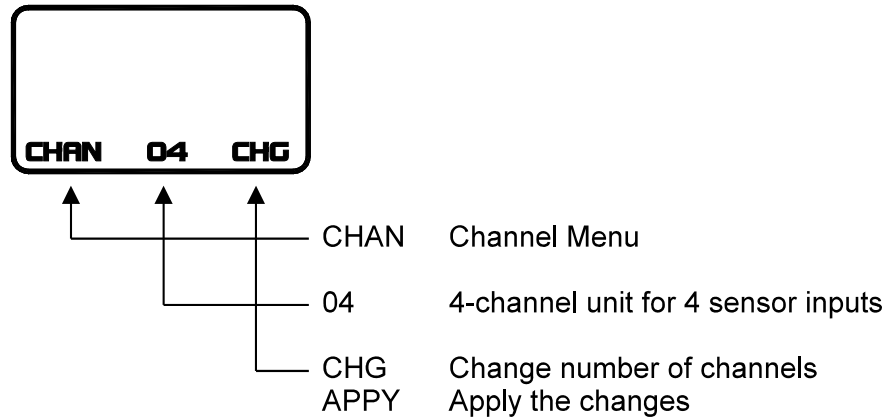

### Channel Menu

---

- The Channel menu controls the number of load channels that the monitor will display.



### To change the Number of Channels

- 1) Push  to enter change mode. Current value is then selected.
- 2) Push  or  to change the value.
- 3) Push  to accept the change, or push  to cancel the change.

**Note:**

When the number of channels is set to 2 for a 2-channel unit, the total load is divided into a left half (Channel 1) and a right half (Channel 2).



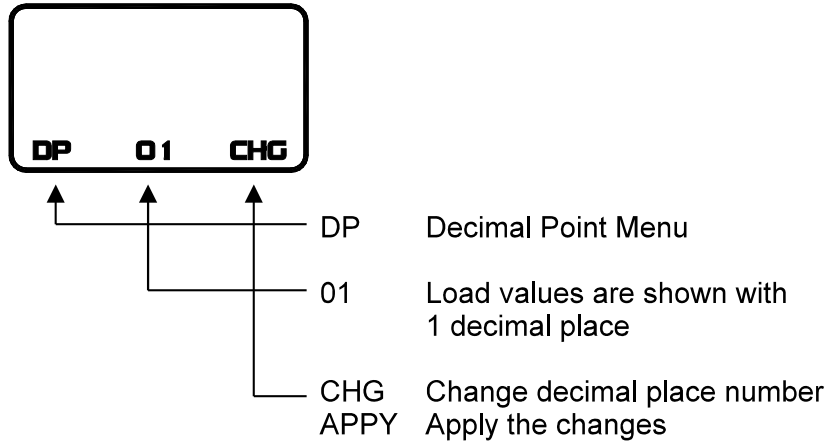

## Decimal Point Menu

---

- The Decimal Point menu controls the precision with which the load values are displayed. Up to 3 decimal places can be displayed.



### To change the Decimal Point

- 1) Push  to enter change mode. Current value is then selected.
- 2) Push  or  to change the value.
- 3) Push  to accept the change, or push  to cancel the change.

## Capacity Menu



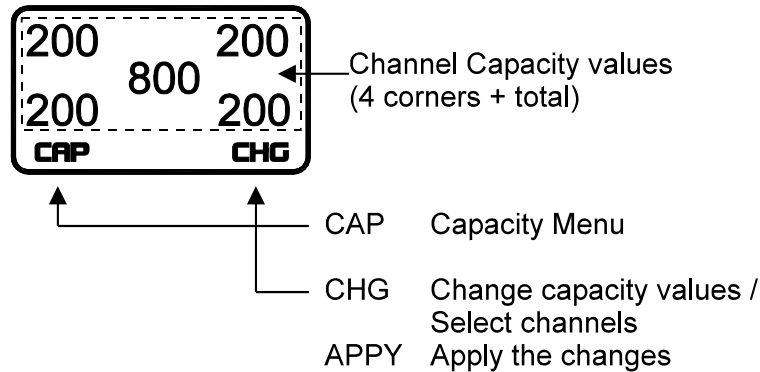





- The Capacity menu allows the user to enter the rated capacity value for the press.



### To view Capacity Values

Capacity values are shown in the associated corners.

### To change Capacity Values

- 1) Push  to enter change mode. Total channel is then selected.
- 2) Push  to select the desired channel.
- 3) Push  or  to change the value, or  
Push  or  to change in a larger increment.
- 4) Push  to accept the change, or push  to cancel the change.
- 5) Repeat from step 2 to make change on other channels.
- 6) Push  to exit change mode.

#### Note:

When the Total Channel value is changed, the values of the corner channels are updated automatically with a value of Total Capacity divided by the number of channels. For example, if a total capacity of 800 is entered, the corner channel capacities will become 200 ( $800 \div 4$  if there are four channels).



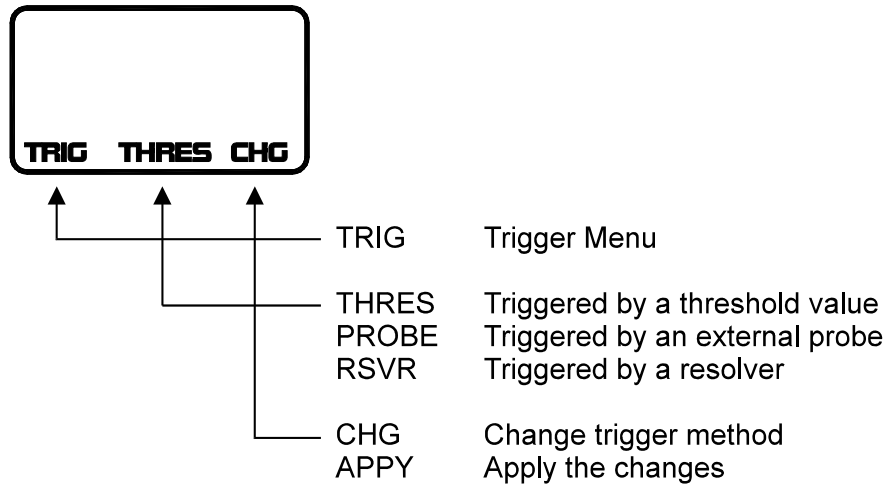

## Trigger Menu

---

- The Trigger menu determines the method that the monitor uses to capture the load.



### To change the Trigger Method

- 1) Push  to enter change mode. Current setting is then selected.
- 2) Push  or  to change the setting.
- 3) Push  to accept the change, or push  to cancel the change.

#### Notes:

- When the trigger method is changed to threshold, the threshold value is automatically set to 6% of capacity. This value can be adjusted on the Threshold menu.
- Choose resolver triggering only if the optional Resolver Board is installed.







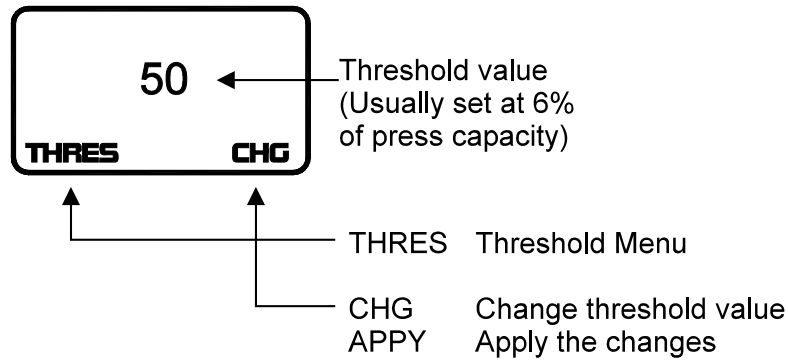

**Threshold Menu (only available when trigger mode is set to Threshold)**

- When using threshold triggering for load capture, the Threshold menu provides a means of adjusting the load value at which the monitor will capture the stroke. Total loads below this value will be ignored.



**To change the Threshold Value**

- 1) Push  to enter change mode. Current setting is then selected.
- 2) Push  or  to change the setting, or  
Push  or  to change in a larger increment.
- 3) Push  to accept the change, or push  to cancel the change.

**Notes:**



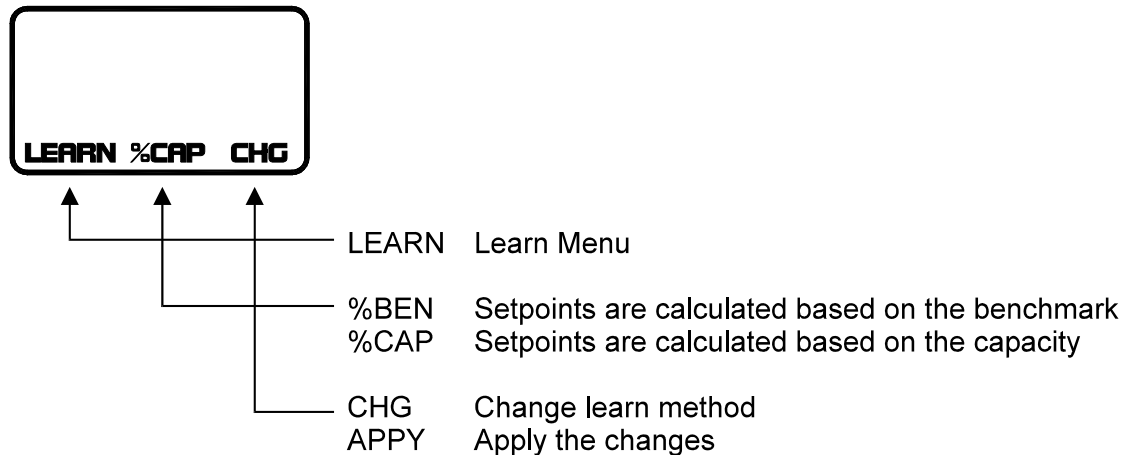

- If the threshold value is set to zero, the trigger method will automatically be set to probe.
- If the threshold value is set to capacity, the trigger method will automatically be set to resolver.

## Learn Menu

- The Learn menu provides a way to control the method that is used to calculate the high and low setpoints when the Learn function is used.



### To change the setpoint learning method

- 1) Push  to enter change mode. Current setting is then selected.
- 2) Push  or  to change the setting.
- 3) Push  to accept the change, or push  to cancel the change.

### Choosing a setpoint learning method

While either method can be chosen, it is important to understand how the setpoint learning method will affect the high and low alarm setpoints. As a general rule, choosing to learn setpoints based on a percentage of capacity will generate a larger range of “good” load values than choosing to learn based on a percentage of the benchmark. This effect is more evident if your normal running peak load is relatively small compared to the capacity.

#### Consider the following example:

A 200-ton capacity press is making good parts at 50 tons. If the high and low setpoints are set to 20%, the following setpoints will be calculated after the Learn function is used.

- %Capacity method:  $200 \text{ tons} * 20\% = 40 \text{ tons}$   
 $\text{Hi Setpoint} = 50 \text{ tons} + 40 \text{ tons} = 90 \text{ tons}$   
 $\text{Lo Setpoint} = 50 \text{ tons} - 40 \text{ tons} = 10 \text{ tons}$
- %Benchmark method:  $50 \text{ tons} * 20\% = 10 \text{ tons}$   
 $\text{Hi Setpoint} = 50 \text{ tons} + 10 \text{ tons} = 60 \text{ tons}$   
 $\text{Lo Setpoint} = 50 \text{ tons} - 10 \text{ tons} = 40 \text{ tons}$

In this example, choosing the %Benchmark method will produce a much tighter range of good values (20 tons) than the %Capacity method (80 tons).

**Delay Menu**

**(only available when trigger mode is set to Threshold)**

- When using threshold triggering for load capture, the Delay menu provides a means of manually controlling the duration of the stroke capture. Load capture begins when the load crosses the threshold value and ends after the fixed delay time. This is advantageous for applications that normally see the load drop below and then rise above the threshold value more than once within a single press stroke (i.e. a double hit).

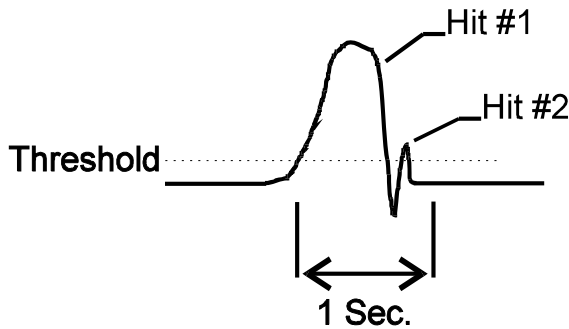
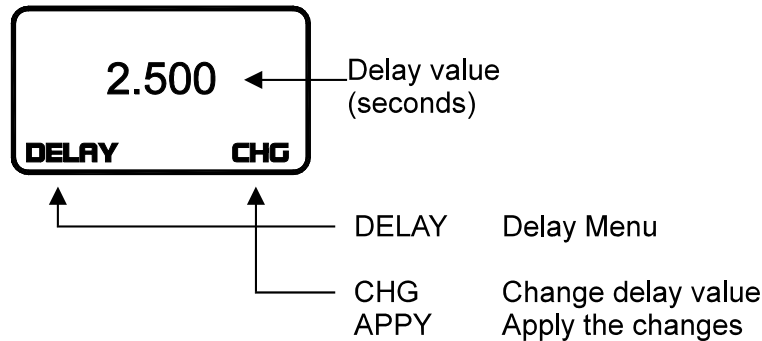

In this example of a double-hit, the load rises above the threshold value, peaks, and then drops below the threshold to end Hit #1. However, the load then rises slightly above threshold once again before finally dropping once more (Hit #2). This behavior will commonly cause the peak tonnage to update twice, which prevents the monitor from displaying the true peak at the end of the stroke. This can be remedied by entering a delay value (1 second in this example), which prevents the stroke from ending too early.

**To change the Delay Value**

- 1) Push to enter change mode. Current setting is then selected.
- 2) Push or to change the setting, or  
Push or to change in a larger increment.
- 3) Push to accept the change, or push to cancel the change.

**Notes:**

- You can choose any time delay value from 0 seconds up to 9.999 seconds.
- Setting the time delay value to zero disables the delay feature. The load capture will end when the load drops below the threshold value.

**Offset Menu** (only available when trigger mode is set to Resolver)

- The press stroke can be viewed as a 360° circle with the top position at 0° (fully opened) and the bottom dead center position at 180° (fully closed). When using resolver triggering for load capture, the offset value allows the resolver position to be zeroed. The offset can be adjusted from 0° (no offset) to 359°.

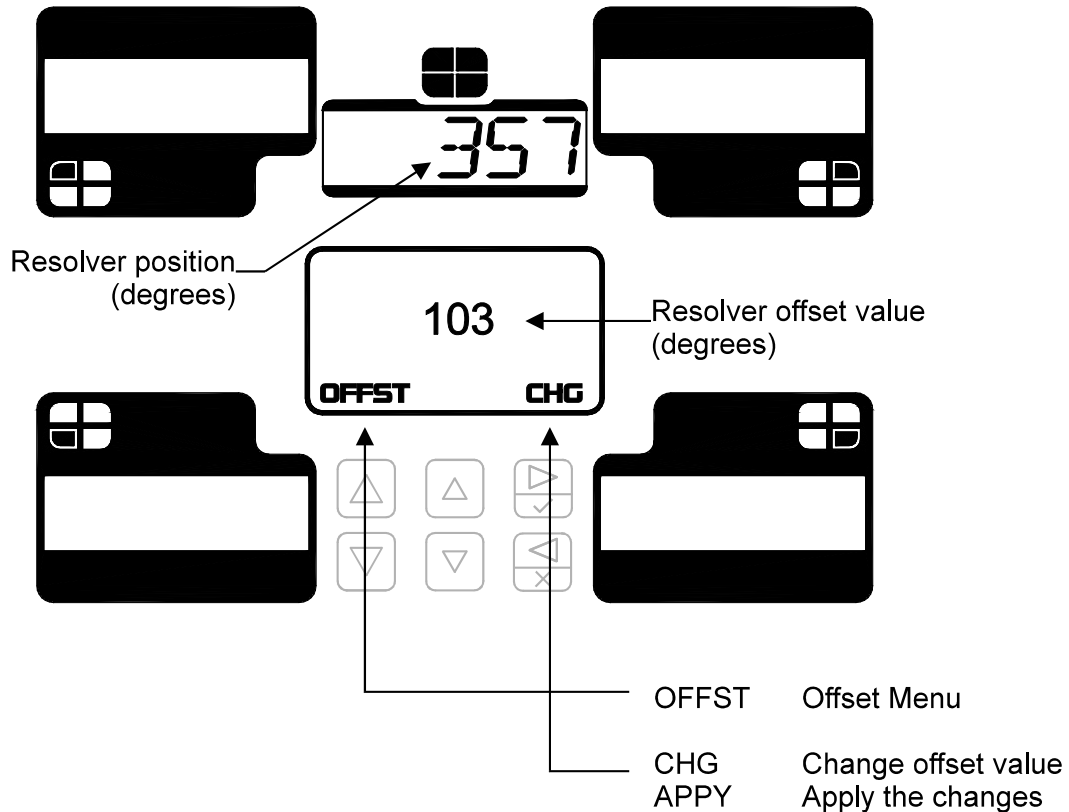

**Determining the Offset Value needed**

- 1) Cycle the press to the top position. This should be 0°.
- 2) Subtract the resolver position shown in the total window from 360 to get the offset value. Refer to the following section to enter the offset.

**To change the Offset Value**

- 1) Push to enter change mode. Current setting is then selected.
- 2) Push or to change the setting, or  
Push or to change in a larger increment.
- 3) Push to accept the change, or push to cancel the change.

After entering the offset value, the resolver position should read zero. If not, re-calculate the offset value as described above.





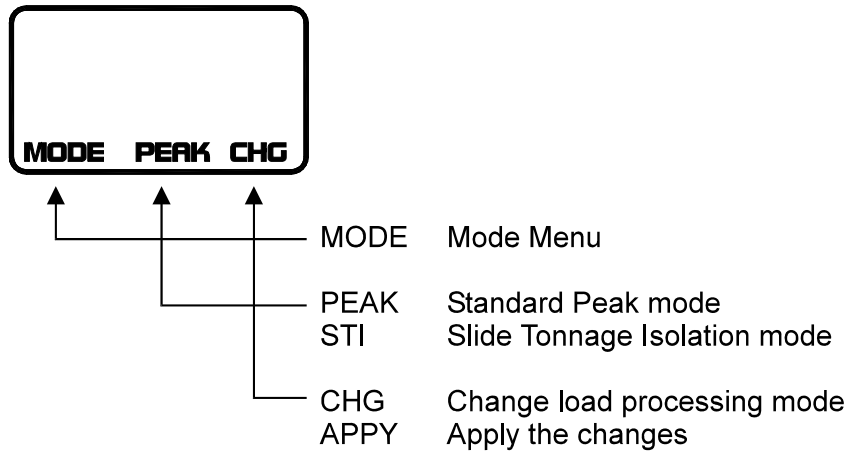

## Mode Menu

- The Mode menu provides an alternate method for processing load data.



### To change the Load Processing Mode

- 1) Push  to enter change mode. Current setting is then selected.
- 2) Push  or  to change the setting.
- 3) Push  to accept the change, or push  to cancel the change.

#### Notes:

- STI mode is not valid for forging applications; therefore the mode should always remain set to PEAK.

## E-Stop Menu

- The E-Stop menu configures the operation of the Emergency Stop (E-Stop) shutdown relay. See page 25 for E-Stop relay location and wiring.

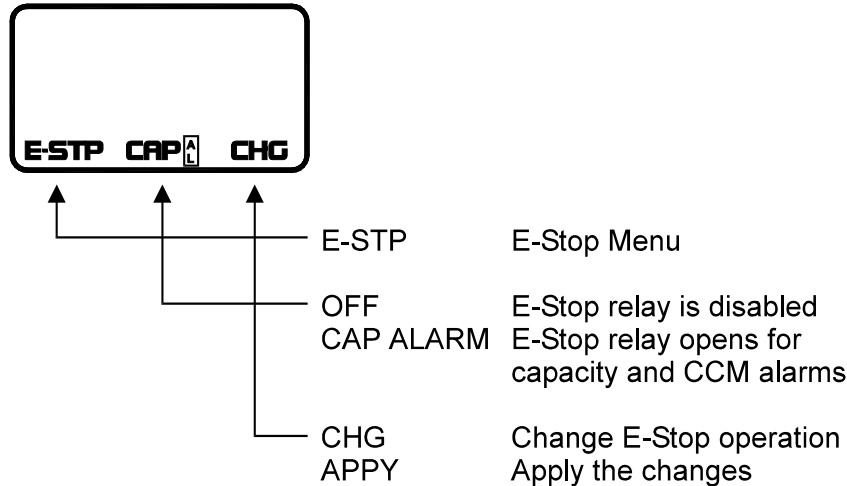

### Description of Emergency Stop relay operation

#### When E-Stop is set to “OFF”:





- All alarms, including capacity alarms, cause the Top-Stop relay to open at the end of the stroke.
- The E-Stop relay has no function.

#### When E-Stop is set to “CAP ALARM”:

- Capacity alarms cause the E-Stop relay to open immediately when an over-capacity load occurs. This also applies to CCM alarms if the optional resolver board is installed.
 

**Warning:** Using the E-Stop relay under heavy loads may result in the ram becoming locked at the bottom of stroke. If this is a concern, the E-Stop relay should not be used.
- The Top-Stop relay will open for high, low, and reverse setpoint violations.

### To change the E-Stop relay operation



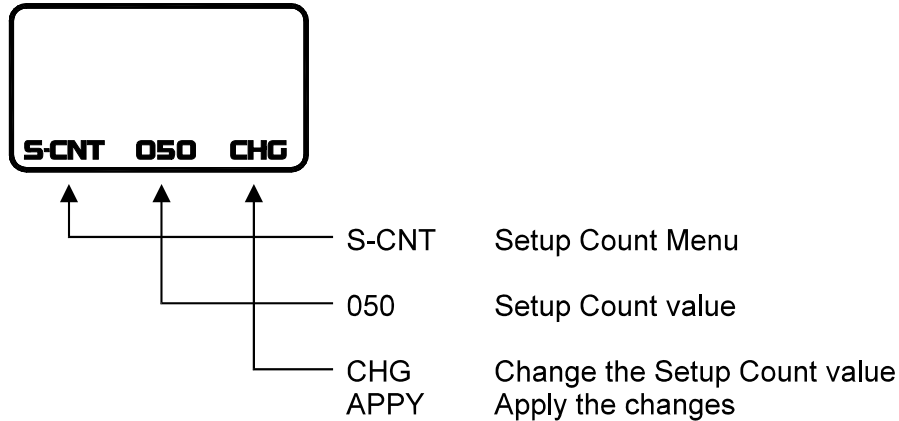

- 1) Push  to enter change mode. Current setting is then selected.
- 2) Push  or  to change the setting.
- 3) Push  to accept the change, or push  to cancel the change.

## Setup Count Menu

- The Setup Count is the maximum number of strokes allowed in Setup mode. It provides a way to ensure that the monitor will not be left in Setup mode indefinitely, protected only by the capacity limits. After the Setup Count value has been reached, the monitor will enter Run mode.



### To change the Setup Count

- 1) Push  to enter change mode. Current setting is then selected.
- 2) Push  or  to change the value.
- 3) Push  to accept the change, or push  to cancel the change.

#### Notes:

- The Setup Count can be set from zero to 200.
- To disable the Setup Count feature, change the value to zero.



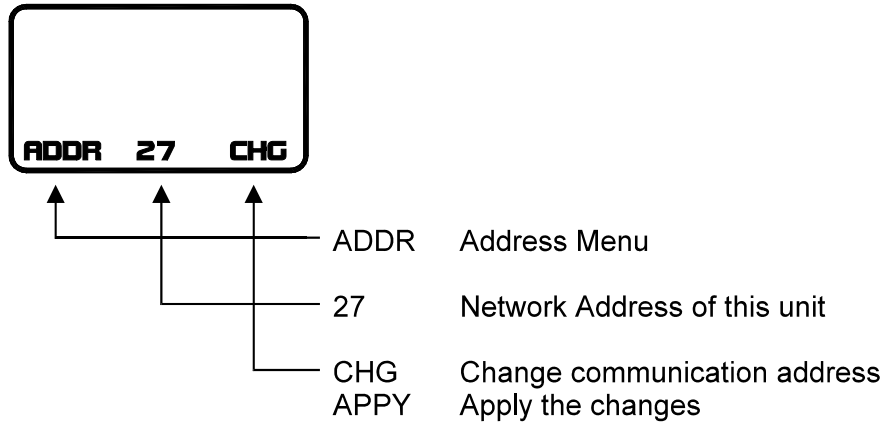

## Address Menu

---

- The Address menu displays the current communications address of the monitor and allows it to be changed to provide a unique networking address for use with PressNet or other communications software.



### To change the Address

- 1) Push  to enter change mode. Current setting is then selected.
- 2) Push  or  to change the setting.
- 3) Push  to accept the change, or push  to cancel the change.





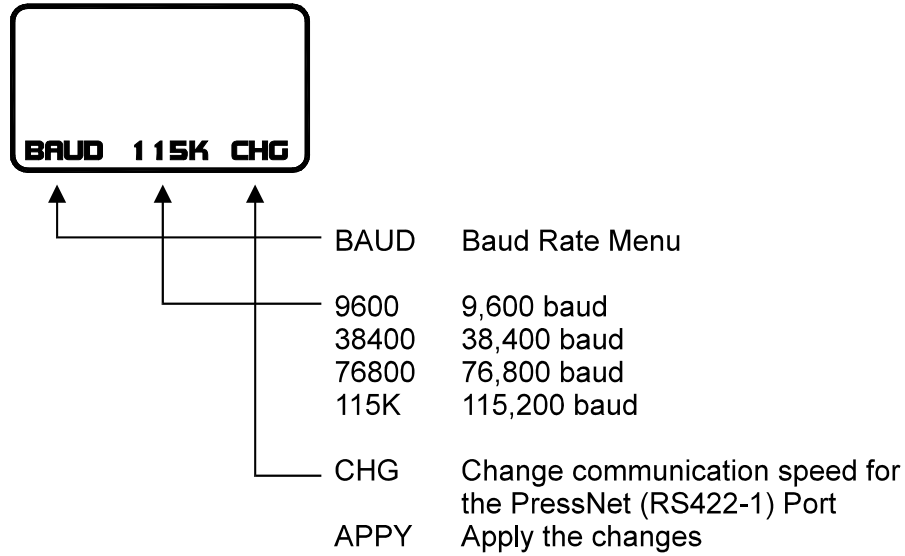

## Baud Rate Menu

- The Baud Rate menu allows the communications speed for the PressNet (RS422-1) Port to be adjusted.



### To change the Baud Rate



- 1) Push  to enter change mode. Current setting is then selected.
- 2) Push  or  to change the setting.
- 3) Push  to accept the change, or push  to cancel the change.

## Calibration Menu

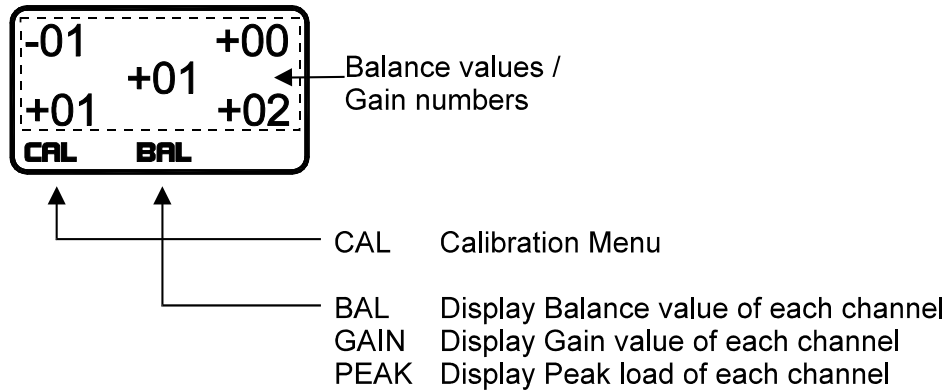
- The Calibration menu allows for balance and gain adjustment for each load channel.



### To view the Balance Values, Gain Numbers, or Peak Load

- 1) Push  or  until the desired item is shown.
- 2) Values are shown in the associated corners.

### To change the Balance Values and Gain Numbers

- Balance values are changed by adjusting the corresponding Balance pot for each channel. The Balance pots are located on the Analog Board, near the sensor input.
- Gain numbers are changed by adjusting the corresponding Gain pot for each channel. The Gain pots are located on the Analog Board, near the sensor input.

**Note:**



The calibration procedure is explained in Section 3.

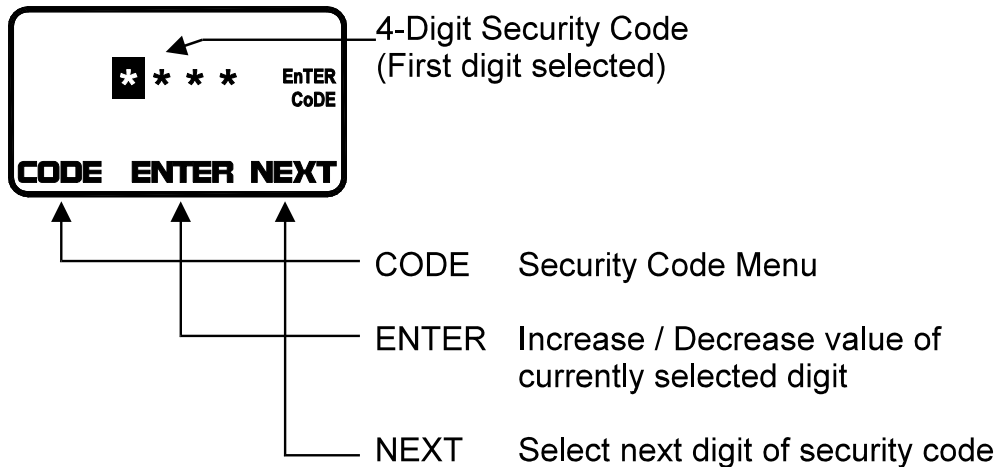

## Security Code Menu (Configuration mode)

- The Security Code menu is used to configure and change the 4-digit security code. When the security code is enabled, most functions in the Operation mode are restricted until the security code is entered.



### To enter the Security Code

The security code consists of four numerical digits, each with a range of 0-9. For security reasons, the digits are not displayed on the LCD as they are entered. The digits are represented by '\*' with the currently selected digit highlighted. Digits are incremented and decremented with the middle arrow buttons,  or . The  button accepts the current digit and advances to the next digit.

- 1) Push  or  to increment or decrement the current digit.
- 2) Push  to accept the current digit and advance to the next digit.
- 3) Repeat steps 1 and 2 until all four digits have been entered.

If the security code is incorrect, the first digit will once again be highlighted. If the security code was accepted, the option to enable/disable or change the security code will appear.

For an example of how to enter the security code, see page 48.

**To enable or disable the Security Code feature**

Once a valid security code has been entered, the following options will appear.

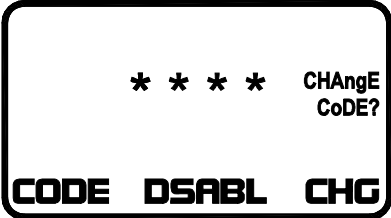

If the security code feature is currently enabled, the **DSABL** (Disable) option appears. In this case, pressing will disable the security code. Once disabled, all settings and features in the Operation mode will be unrestricted and the Operation mode's Security Code menu will not appear.

Similarly, if the security code feature is currently disabled, the **ENABL** (Enable) option appears. In this case, pressing will enable the security code for the Operation mode.

**To change the Security Code**

Once a valid security code has been entered, the authorized user then has the option to change the security code if desired. You will notice a message on the LCD asking if you wish to change the security code.

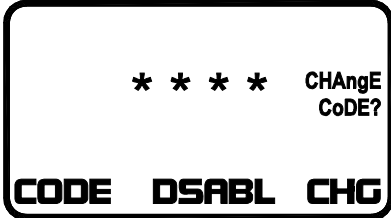

To begin changing the security code, press the button. The familiar security code entry screen appears. Enter the new 4-digit code. After the new security code has been entered, the LCD will prompt you to verify the new code. Enter the same new 4-digit security code again. If you entered the exact same code both times, you will get a message that the code was changed. If not, you will be informed that the change failed. See the following example for the sequence.

**Sequence to Change the Security Code**

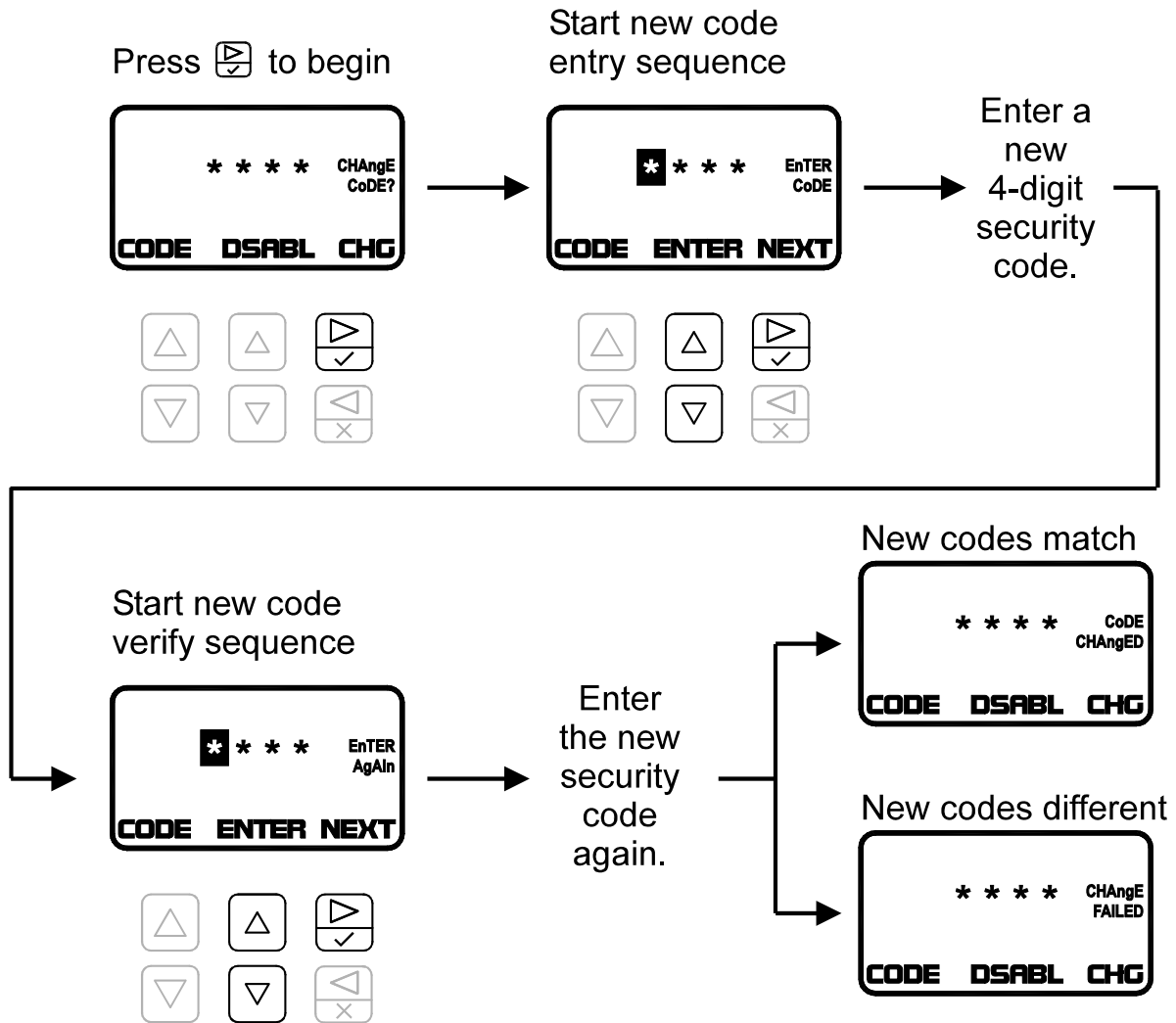

**To reset the Security Code**

There is a way to reset the security code to its default value of 4-1-7-0, in case the code is forgotten.

First, navigate to the Configuration mode's Security Code menu. Then follow this sequence exactly as shown:

**Sequence to Reset the Security Code**

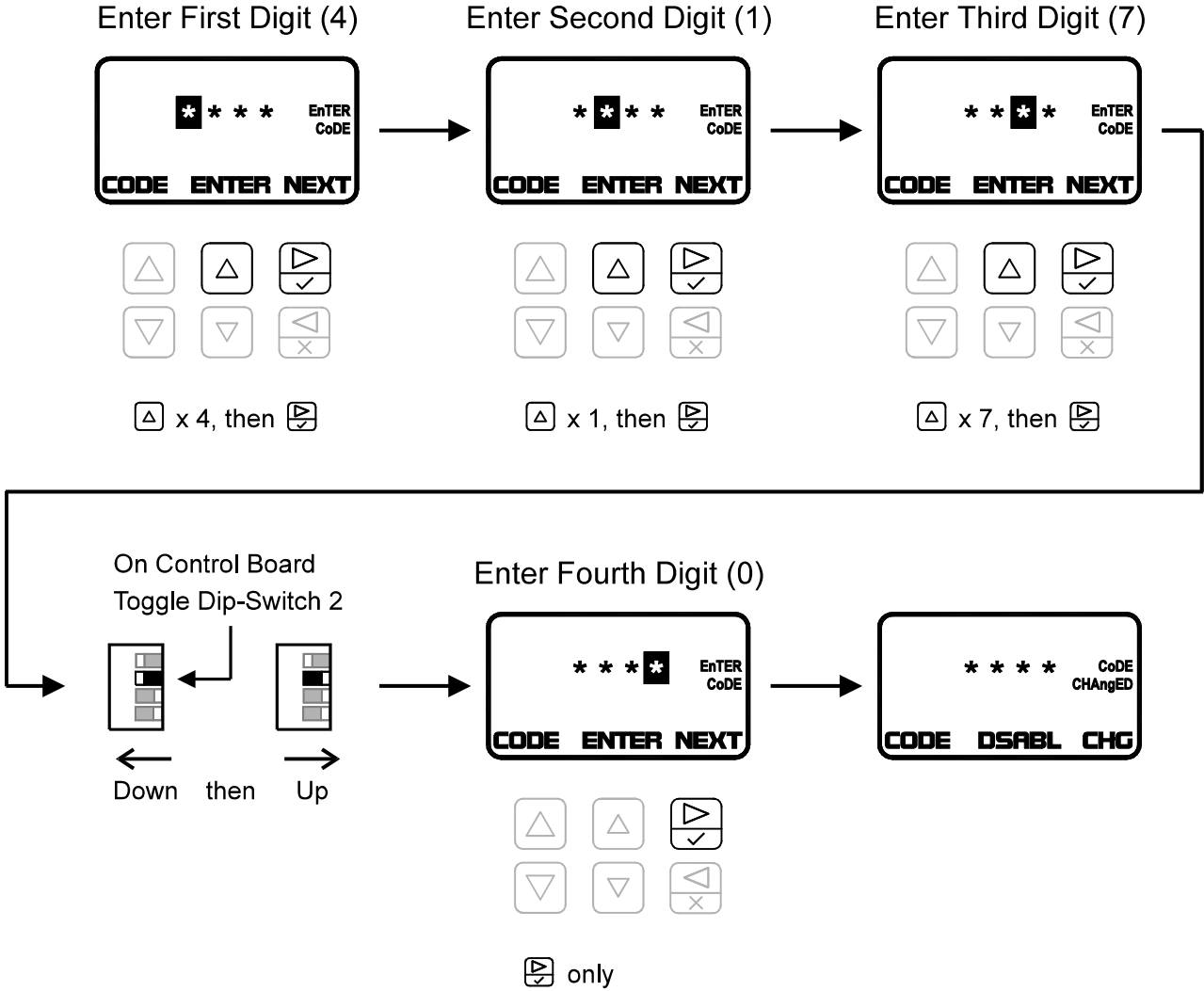

Once the security code is reset to its default value, you may then change the code by following the instructions from the “**To change the Security Code**” section.

# 3: Calibration Procedure

---

Use the following steps for proper load calibration of the PWi Forging unit.

## 1) Put the PWi Forging in Setup Mode (see page 33 for details).

## 2) Set Press Capacity

- A) Enter the Configuration mode by toggling Dip-Switch 1 to the down position (see page 28 for location of Dip-Switch 1).
- B) Use the ▲ or ▼ buttons to navigate to the Capacity menu.
- C) Enter the press capacity for the total and each channel. Refer to the *Capacity Menu* section on page 53 for more detail.

## 3) Balance the Tonnage Sensors

- A) Make sure the press is under no load.
- B) Use the ▲ or ▼ buttons to navigate to the Calibration menu.
- C) Open the PWi Forging enclosure and locate the Balance and Gain pots on the Analog Board (see Figure 1.7 and Figure 1.8).
- D) Adjust the balance pot for CH1 until the balance value for channel 1 reads zero. Turn the pot clockwise to increase the balance value and counter-clockwise to decrease the balance value.

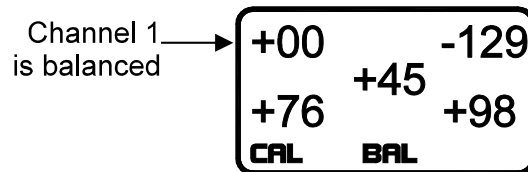

- E) Repeat for each of the remaining channels.



## 4) Find the Shut Height of the Press

- A) Jog the press until the ram is at bottom dead center (BDC) or 180° without any load cells or die in the press.
- B) Determine the amount of spacers needed with your load cells. Cycle the press without load cells to insure correct height.

### 5) Place the Load Cells in the Correct Position in the Press

- A) All load cells should be equal distance from the sides and front and rear. For example, 12” from the sides, 10” from front and rear. Load cells are typically placed at each corner of the press’s bed.
- B) Cycle the press without hitting the load cells first.
- C) Place cardboard on the top and bottom of the load cells.

### 6) Cycle the Press



- A) While still in the Calibration menu, push  or  to display the **PEAK** tonnage.
- B) Further adjust the shut height so that the press impacts the load cells and generates a load at 100% of press capacity. See warning below.

**WARNING:**

Depending on the press capacity and the size of the load cells being used, loading the press at capacity with load cells could indent the ram or bolster. To prevent this situation from happening, do one of the following:

- a) Calibrate the press only up to 80% of capacity, or
- b) Use larger load cells to increase the loading surface. For instance, to calibrate a 400 Ton press at capacity, use (4) 250 Ton load cells instead of (4) 100 Ton load cells.

### 7) Gather, Record, and Enter Data

- A) Record the load cell numbers for each of the channels. These are the load values of the press corners.
- B) Record the peak tonnage values from the PWi Forging.
- C) While still in the Calibration menu, push  or  to display the **GAIN** numbers. This enables the PWi Forging’s shunt. Record the Gain numbers.

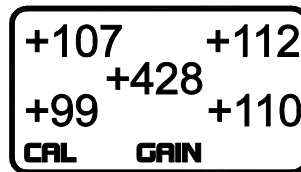





- D) Use the following formula to determine the new gain number:

$$\text{New Gain Number} = (\text{Load Cell reading} \div \text{Peak Tonnage reading}) \times \text{Current Gain}$$



- E) Repeat the calculation for each channel.





- F) Adjust the gain pot for CH1 until the gain number for channel 1 equals the new calculated gain number. Turn the pot clockwise to increase the gain number and counter-clockwise to decrease the gain number. Repeat for each of the remaining channels.
- G) Push  or  to display the **BAL** (balance) values. Use the balance pots to re-balance the channels if needed.
- H) Push  or  to display the **GAIN** numbers. If they are not equal to the calculated gain numbers, re-adjust them. Repeat steps **F-H** as needed.

## 8) Verify Results and Repeat



- A) While still in the Calibration menu, push  or  to display the **PEAK** tonnage.
- B) Cycle the press.
- C) Verify that the load cell values and the PWi Forging's peak tonnage values are same. If not, repeat step 7 until the values are the same.

## 9) Make Linearity Check

- A) Raise the shut-height in .020 to .030 inch increments to decrease tonnage.
- B) Cycle the press and impact the load cells.
- C) Compare the tonnage applied to the load cells to the tonnage displayed on the PWi Forging. These values should be documented.

## 10) Document calibration details on the Calibration Sheet (Form #1224) provided and file it for future reference.

## 11) Record Gain Numbers

- A) While still in the Calibration menu, push  or  to display the **GAIN** numbers.
- B) Record these numbers on the calibration card located on the door inside of the unit. See section 4 for details on the calibration card.

## 12) Calibration Complete

The calibration procedure is now complete. Contact Toledo Integrated Systems' Service Department for assistance if needed. Our Service Department can be reached at 419-867-4170, Monday through Friday, 8:00 AM to 5:00 PM.



# 4: Calibration Information Label

The Calibration Information Label is provided to document the Gain Numbers (CAL#) and other important configuration data. This card is located inside of the unit on the door. Below is an example of the information that should be documented.

CALIBRATION INFORMATION				
Cal. By	<b>JOHN DOE</b>		Date	<b>7-15-12</b>
Press No.	<b>3</b>	Address	<b>2</b>	
Capacity (CH0)	<b>2000</b>	Unit	<b>kN</b>	
<input checked="" type="checkbox"/> Thres. Value	<b>120</b>	<input type="checkbox"/> Probe		
	CH1	CH2	CH3	CH4
CAL #	<b>1015</b>	<b>1019</b>	<b>994</b>	<b>1006</b>
<input type="checkbox"/> STI Value	Delay Value		<b>1.3 SEC</b>	
Notes				

- 1) **Cal By**  
The name of the person that performed the calibration procedure.
- 2) **Date**  
The date that the calibration was completed.
- 3) **Press No.**  
The press on which the monitor is installed.
- 4) **Address**  
The network/communication address for the monitor.
- 5) **Capacity (CH0)**  
The total capacity of the press. For a double-action press, this is the capacity of the outer slide.
- 6) **Unit**  
The type of load being measured. Common examples include **Tons** and **kN** (kiloNewtons).
- 7) **Thres. Value**  
If the trigger method is set to **Threshold**, check this box and record the configured threshold value.
- 8) **Probe**  
If the trigger method is set to **Probe**, check this box.
- 9) **CAL# (CH1-4)**  
Record the Gain Numbers from step 11 of the Calibration Procedure here.
- 10) **STI Value**  
If the mode is set to **STI**, check this box and enter the STI configuration number here.
- 11) **Delay Value**  
The configured delay value, if used.
- 12) **Notes**  
Enter any important notes related to the monitor's configuration in this area.



If the optional Resolver Board was purchased, an additional calibration label is included to document the resolver information and/or the channel 6-9 analog input information.

CALIBRATION INFORMATION				
Cal. By	<b>JOHN DOE</b>		Date	<b>7-15-12</b>
Press No.	<b>3</b>		Address	<b>2</b>
Capacity (CH0)	<b>2000</b>		Unit	<b>kN</b>
<input type="checkbox"/> Thres. Value			<input type="checkbox"/> Probe	
	CH1	CH2	CH3	CH4
CAL #	<b>1015</b>	<b>1019</b>	<b>994</b>	<b>1006</b>
<input type="checkbox"/> STI Value	Delay Value			
Notes				

Capacity (CH5)	<b>4000</b>																			
<input checked="" type="checkbox"/> Resolver	Offset Value <b>285</b>																			
	CH6	CH7	CH8	CH9																
	<b>1575</b>	<b>1569</b>	<b>1611</b>	<b>1543</b>																
<div style="display: flex; justify-content: space-between;"> <div style="width: 45%;"> <p><b>Additional Resolver / Analog Board</b></p> </div> <div style="width: 45%;"> <p><b>Resolver Configuration</b></p> <table border="0"> <tr> <td>Slave</td> <td><input type="checkbox"/></td> <td>Master</td> <td><input checked="" type="checkbox"/></td> </tr> <tr> <td>Rot</td> <td><input type="checkbox"/></td> <td>+4</td> <td><input checked="" type="checkbox"/></td> </tr> <tr> <td>Stat1</td> <td><input checked="" type="checkbox"/></td> <td>+2,3,5</td> <td><input type="checkbox"/></td> </tr> <tr> <td>Stat2</td> <td><input checked="" type="checkbox"/></td> <td>+2,3,5</td> <td><input type="checkbox"/></td> </tr> </table> </div> </div> <p><small>Wiring and setup for CH6-9 are similar to CH1-4.</small></p>					Slave	<input type="checkbox"/>	Master	<input checked="" type="checkbox"/>	Rot	<input type="checkbox"/>	+4	<input checked="" type="checkbox"/>	Stat1	<input checked="" type="checkbox"/>	+2,3,5	<input type="checkbox"/>	Stat2	<input checked="" type="checkbox"/>	+2,3,5	<input type="checkbox"/>
Slave	<input type="checkbox"/>	Master	<input checked="" type="checkbox"/>																	
Rot	<input type="checkbox"/>	+4	<input checked="" type="checkbox"/>																	
Stat1	<input checked="" type="checkbox"/>	+2,3,5	<input type="checkbox"/>																	
Stat2	<input checked="" type="checkbox"/>	+2,3,5	<input type="checkbox"/>																	

13) **Capacity (CH5)**

The total capacity associated with load sensors 6-9. For example, in the case of a double-action press where sensors 6-9 are used to measure the load for the inner slide, the CH5 capacity is the total capacity for the inner slide.

14) **Resolver**

If the trigger method is set to **Resolver**, check this box.

15) **Offset Value**

When using **Resolver** triggering, enter the offset value that is required to zero the press angle.

16) **CAL# (CH6-9)**

Record the Gain Numbers from step 11 of the Calibration Procedure here.

17) **Resolver Configuration**

Record the resolver dip switch settings from the Resolver Board here.

# 5: Operator's Guide

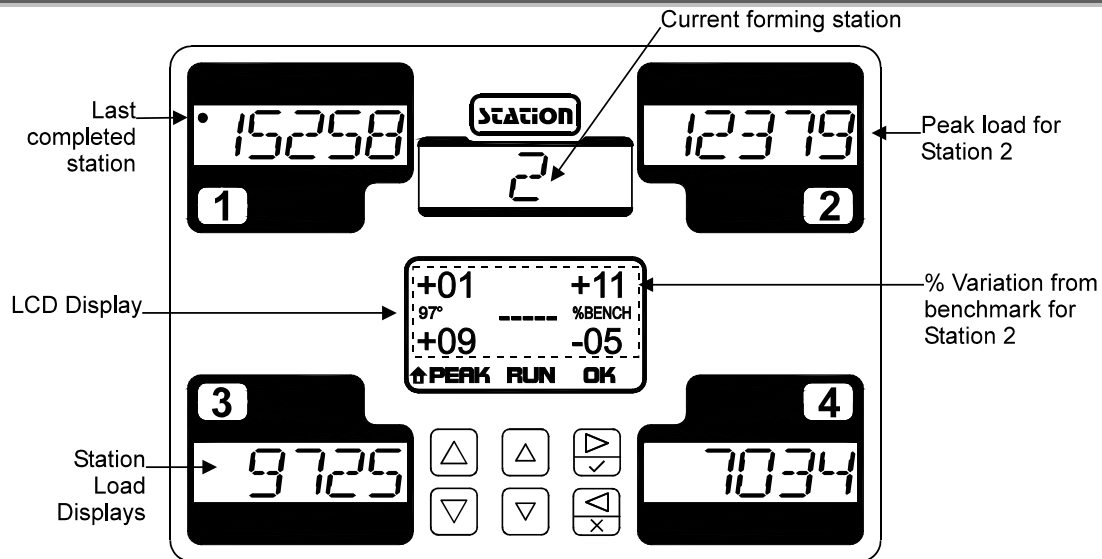

The PWi Forging displays a variety of information by organizing it into menus. The Home menu is shown above. The Corner Displays show peak station load and the LCD Display shows % Variation from the Benchmark for each station. From this menu, you can place the PWi Forging into Setup Mode or Learn Mode and view the run status.

- While setting a die in the press, place the PWi Forging into Setup Mode by pressing the and buttons until the LCD Display shows **SETUP**. Press the button to accept. Run material through the press until a good part is formed. If running an established part whose setpoints have been saved to a job number, follow the instructions below to load the job. Otherwise, place the PWi Forging into Learn Mode by pressing the and buttons until the LCD Display shows **LRN**. Press the button to accept. After one sequence through the stations, the PWi Forging establishes a new benchmark and calculates new high and low setpoints based on the percentage settings from the Setpoint menu.
- Jobs save the setpoints related to a part so that you do not have to relearn them every time that part is ran. To load a job, use the and buttons to access the **JOB** menu. The current job number is shown above the and buttons on the LCD Display. To change the job number, press the button, then press the or buttons to increase or decrease the job number. When the desired job number is shown, press the button to load it.
- To avoid nuisance alarms and shutdowns while adjusting the press, put the PWi Forging in Setup Mode, as described above. Setup Mode still protects the press from an over-capacity hit, but it will not shut the press down for a high or low setpoint violation.
- The high and low setpoints can be displayed by using the and buttons to access the **SETPT** (Setpoint) menu. While on the Setpoint menu, use the and buttons to display the **HI-%** (High %), **LO-%** (Low %), and other setpoints. The high and low percentages are shown on the LCD Display for each station and the actual high and low setpoints are shown on the Station Load Displays.
- When an alarm occurs, the status on the Home menu will change to **ALM** and the Station Load Display(s) for the violated channel(s) will flash. Press the button to go to the **ALARM** Menu. The type of alarm and the station number are shown above the and buttons on the LCD Display. If more than one alarm has occurred you can use these buttons to scroll through the list of alarms. To reset an alarm, press the button.



# 6: Appendix

---

- I) Sensor Installation (Doc# 11080)**
- II) Calibration Sheets (2) (Form# 1224)**





# INSTALLING T400 LOAD SENSORS

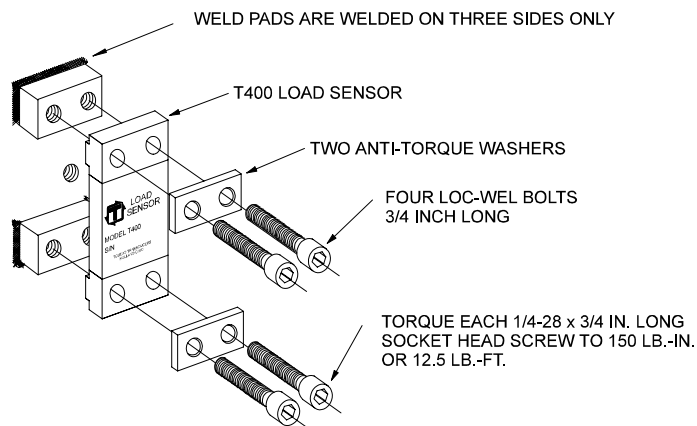
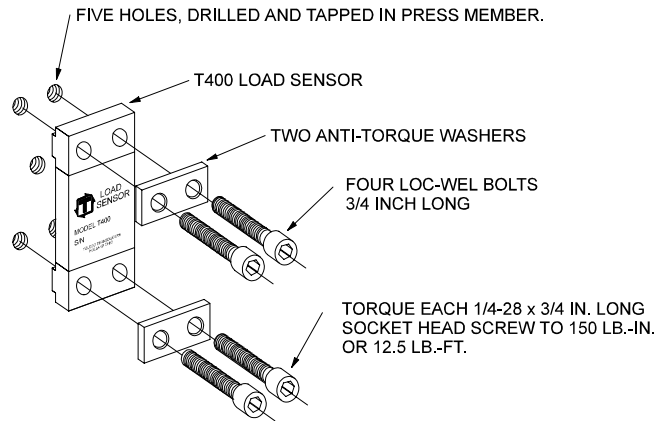

The above illustrations represent the proper arrangement of Model T400 Load Sensor kit parts using either the Drill and Tap method or the Weld method.

A proper installation is necessary to produce good results.

Before installing the sensors, please read the appropriate instructions listed below.

Sensor Placement	Page 2
Press Frame	Page 3
Pitman Mount	Page 4
Drill and Tap Method of Installing Sensors	Page 5
Weld Method of Installing Sensors	Page 6
T400 Enclosure Mounting Details	Page 7

**NOTES:**

- 1) (2) SENSORS REQUIRED
- 2) (2) SENSOR ENCLOSURES ARE INCLUDED. THESE HELP PROTECT THE T400 SENSOR GAUGES. THESE ENCLOSURES INCLUDE 1/2" KNOCK-OUT HOLES. IF CONDUIT IS USED, WE SUGGEST USING 1/2" STRAIN RELIEFS IN THE KNOCK-OUT HOLES.

## SENSOR PLACEMENT

Sensor location must be determined. You have two locations. The front or the rear of the press. (Shown in the shaded area.)

### HOW TO DETERMINE THE BEST LOCATION

\* MEASURE THE REAR THICKNESS \_\_\_\_\_ REAR

\* MULTIPLY BY THREE X 3 =

\* MEASURE THE FRONT THICKNESS \_\_\_\_\_ FRONT

If the front thickness is smaller than value in , then mount sensors in the front. (This is the most common.)  
If the front thickness is larger, then place the sensor in the rear. Adjust the input connection for compression readings instead of tension.

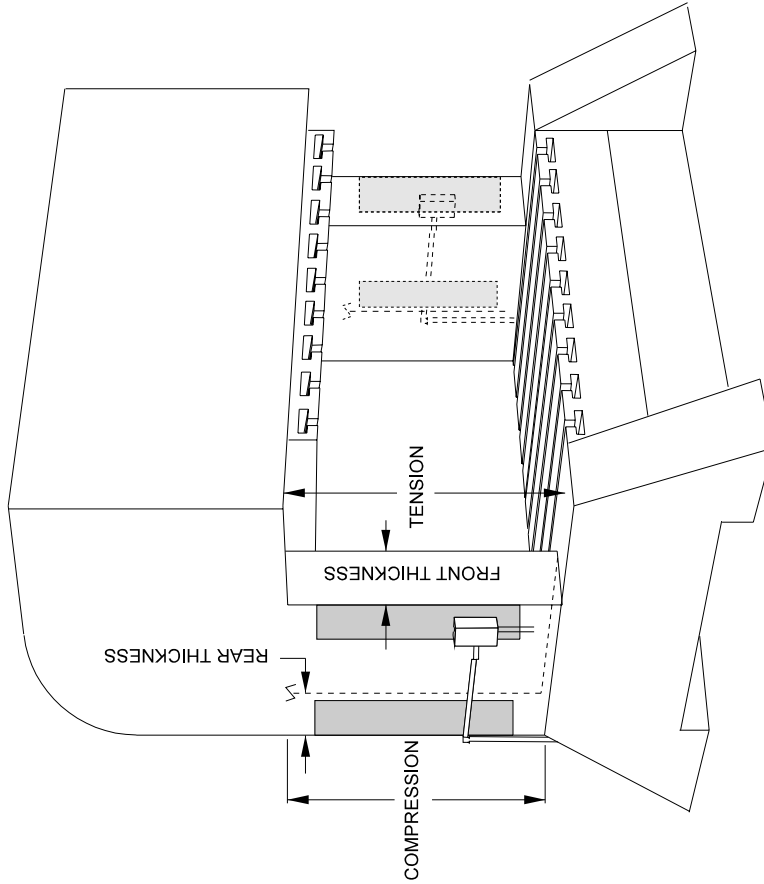

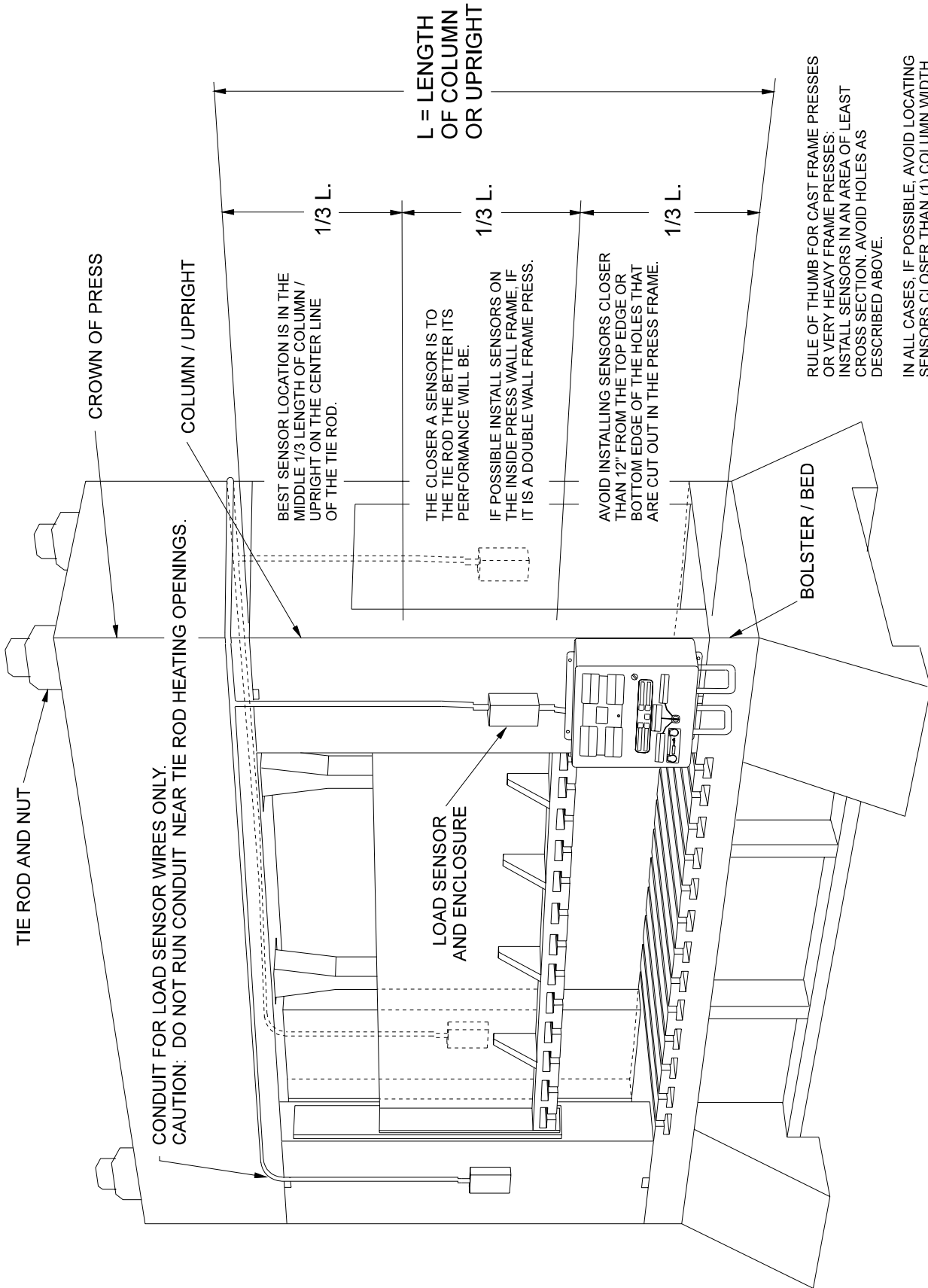

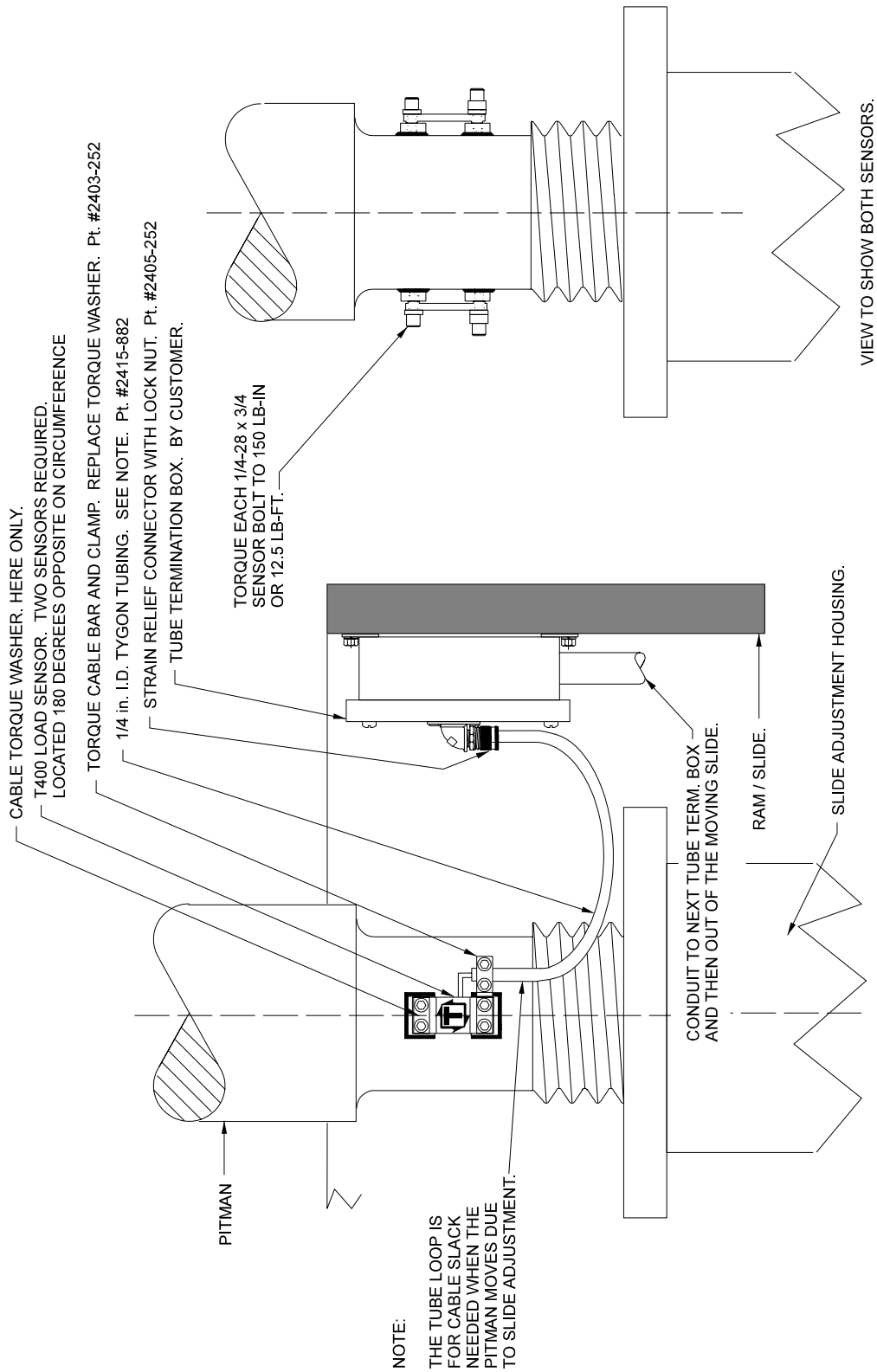

# USING THE T400 SENSOR INSTALLATION FIXTURE KIT No. 1977-749

## (METRIC INSTALLATION FIXTURE KIT No. 1974-749)

### *DRILL AND TAP METHOD FOR MOUNTING SENSORS*

BE SURE THE SENSOR LOCATION FOLLOWS THE BEST LOCATION DESCRIBED ON THE PREVIOUS PAGES.

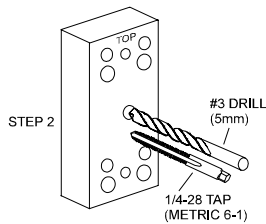

STEP 1 Remove all paint and grease from sensor mount area. If the machine surface is flat (total indicated reading of .002”) and smooth (125 μ in.) the load sensor can be bolted directly to the surface.

STEP 2 Drill and tap the center hole for mounting the fixture to the press member. This hole should be ½ inch (13mm) deep.

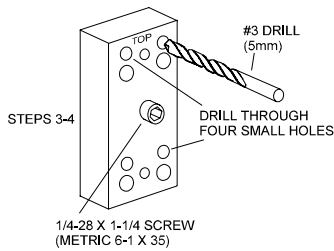

STEP 3 Bolt the fixture to the press member using the ¼-28 by 1-¼ inch (M6-1 x 35) long socket head cap screw in the center of the fixture.

STEP 4 Insert the number 3 drill (5mm) into the smaller corner hole and drill out all four holes to a depth of ¾ of an inch (19mm.)

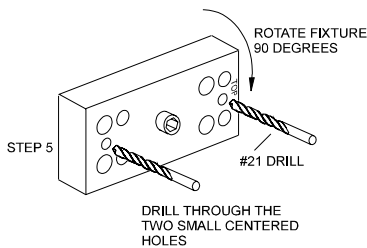

STEP 5 Loosen the fixture. Rotate the fixture 90 degrees clockwise. Tighten the center screw of the fixture. Insert the number 21 drill into the small centered hole and drill out both holes to a depth of 3/8 of an inch. These holes are for mounting the sensor enclosure. The fixture does not allow for tapping these holes. They are tapped without the fixture. Enclosure mounting is not done in metric.

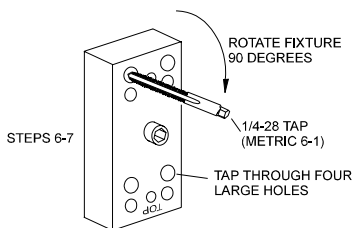

STEP 6 Loosen the fixture. Rotate the fixture another 90 degrees clockwise such that the larger corner holes line up with the holes drilled in Step 4. Insert a tap to be sure the holes line up. Lock the fixture in place by tightening the center screw.

STEP 7 Insert the tap into the larger tap guide holes and tap each hole.

BE SURE TO USE PLENTY OF TAPPING FLUID.

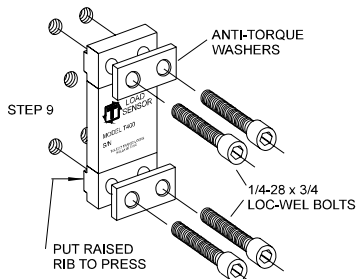

STEP 8 Remove the fixture and repeat Steps 1-7 for each additional sensor mounting position.

STEP 9 Mount the sensor with the raised rib to the press. The anti-torque washers should go between the screw and the sensor body. Torque each ¼-28 x ¾ in. long socket head cap screw to 150 LB.-IN or 12.5 LB.-FT.

# USING THE T400 SENSOR INSTALLATION FIXTURE KIT No. 1977-749

## *WELD PAD METHOD FOR MOUNTING SENSORS*

BE SURE THE SENSOR LOCATION FOLLOWS THE BEST LOCATION DESCRIBED ON THE PREVIOUS PAGES.

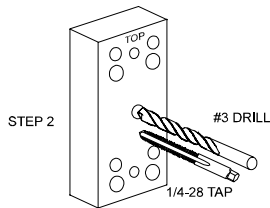

STEP 1 Remove all paint, grease, and or rust from surface to be welded. (Surface should be flat T.I.R. 1/32 of an inch.)

STEP 2 Drill and tap the center hole for mounting the fixture to the press member. This hole should be 1/2 inch deep. (Optional)

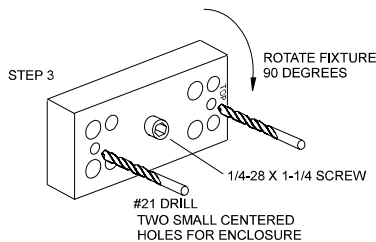

STEP 3 Bolt the fixture to the press member using the 1/4-28 by 1-1/4 inch long socket head cap screw in the center of the fixture. Orient the fixture as shown and drill out the #21 holes to a depth of 3/8 of an inch for the enclosure mounting. The fixture is not used for tapping these holes. (Optional)

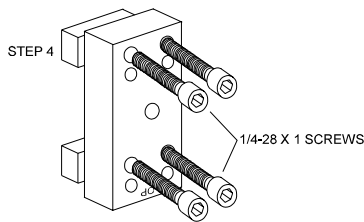

STEP 4 Remove the fixture from the press member. Bolt the weld pads to the fixture with 1/4-28 by 1 inch long socket head cap screws provided. Reattach the fixture with the weld pads bolted on using the center hole as in Step 3. Orient the fixture as shown.

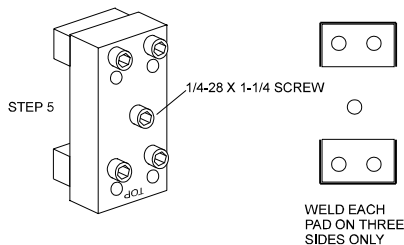

STEP 5 Weld the weld pads to the press member. (BE SURE TO ONLY WELD THE WELD PADS ON THREE SIDES AS SHOWN.) A single pass is sufficient. Do not remove the fixture until slag is removed and or assembly has cooled. When welding cast iron, use a dry nickel rod such as: Lincoln Electric "Soft Weld", Hobart "NI Cast 99", or MB Weld Prod. "MG 210. Strike arc on steel then puddle into the cast iron.

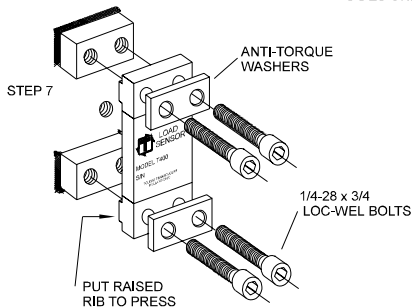

STEP 6 Remove the weld fixture. DO NOT WELD AFTER FIXTURE IS REMOVED. The 4 screws holding the pads to the fixture and the 1 center screw may be discarded. DO NOT USE THE FOUR 1 INCH LONG SCREWS TO ASSEMBLE SENSOR. The sensor kit contains four 3/4 inch long screws for assembling the sensor to the press member. Weld pad surface must be clean – no weld bumps, scratches, etc. Be sure the weld pad tapped holes are clean and bottom of holes are free of weld flash.

STEP 7 Mount the sensor with the raised rib to the press. The anti-torque washers should go between the screw and the sensor body. Torque each 1/4-28 x 3/4 in. long socket head screw to 150 LB.-IN or 12.5 LB.-FT.

# SENSOR ENCLOSURE MOUNTING

USE 10-32 TAP IN THE TWO 3/8" DEEP HOLES THAT WERE DRILLED WITH THE FIXTURE IN THE PREVIOUS INSTRUCTIONS. MOUNT THE ENCLOSURE TO THE PRESS MEMBER AND RUN 1/2 INCH CONDUIT TO THE LOAD MONITOR ENCLOSURE.

RUN SENSOR CABLE THROUGH CONDUIT. PLACE SENSOR ON MOUNTING HOLES. PLACE ANTI-TORQUE WASHERS OVER SENSOR HOLES. SCREW IN SENSORS BOLTS, (4) EACH, FINGER TIGHT. USE ONLY THE 1/4-28 x 3/4 "LOC-WEL" BOLTS THAT ARE IN THE SENSOR PACKAGE. TORQUE EACH 1/4-28 x 3/4 SCREW TO 150 LB.-IN. OR 12.5LB.-FT. ASSEMBLE BOX COVER.

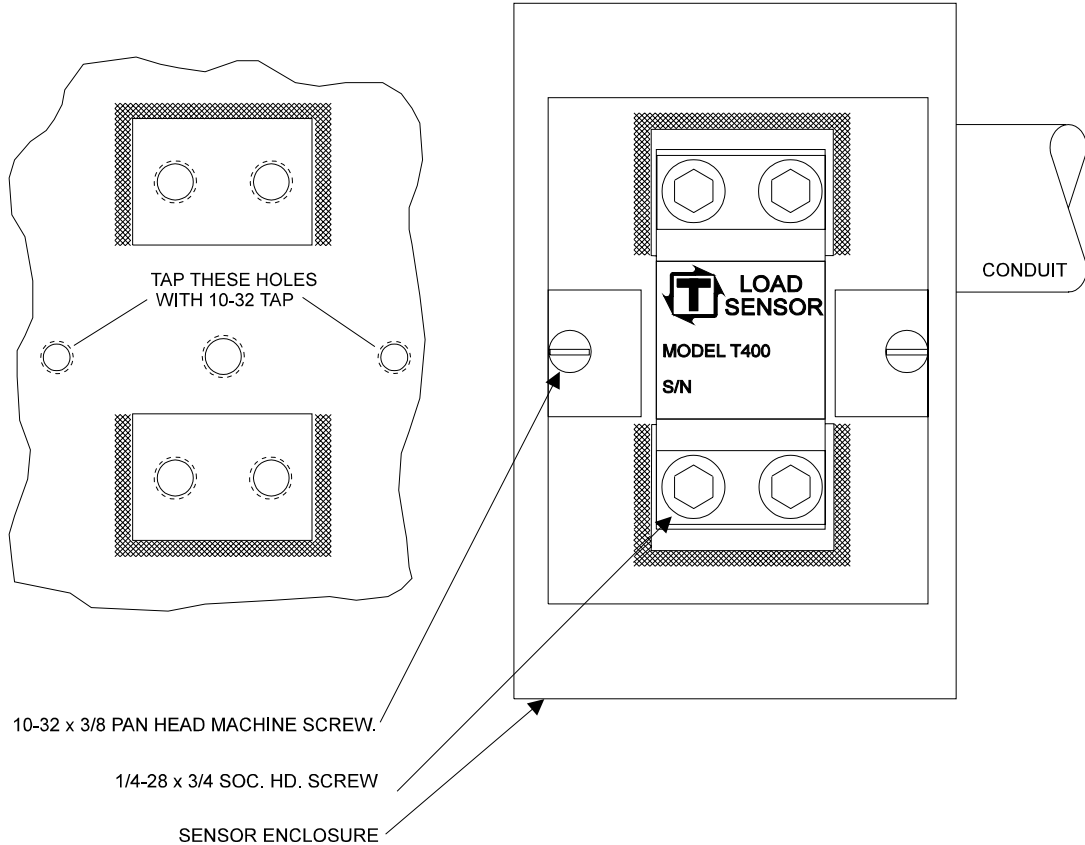





COMPANY: \_\_\_\_\_

DATE: \_\_\_\_\_

\_\_\_\_\_  
\_\_\_\_\_

PRESS SERIAL No: \_\_\_\_\_

PRESS (Type and & No.): \_\_\_\_\_

CONTACT: \_\_\_\_\_

PRESS CAPACITY: \_\_\_\_\_

PHONE: (\_\_\_\_) \_\_\_\_\_

LOAD MONITOR MODEL: \_\_\_\_\_

SERVICE ORDER #: \_\_\_\_\_

MONITOR SERIAL No. \_\_\_\_\_

SLIDE-ADJUST INDICATOR

TONNAGE APPLIED TO **LOAD CELLS** ON PRESS

TONNAGE DISPLAYED ON **LOAD MONITOR**

LR	<input type="text"/>	TOTAL	<input type="text"/>	RR
LF	<input type="text"/>		<input type="text"/>	RF

LR	<input type="text"/>	TOTAL	<input type="text"/>	RR
LF	<input type="text"/>		<input type="text"/>	RF

LR	<input type="text"/>	TOTAL	<input type="text"/>	RR
LF	<input type="text"/>		<input type="text"/>	RF

LR	<input type="text"/>	TOTAL	<input type="text"/>	RR
LF	<input type="text"/>		<input type="text"/>	RF

LR	<input type="text"/>	TOTAL	<input type="text"/>	RR
LF	<input type="text"/>		<input type="text"/>	RF

LR	<input type="text"/>	TOTAL	<input type="text"/>	RR
LF	<input type="text"/>		<input type="text"/>	RF

LR	<input type="text"/>	TOTAL	<input type="text"/>	RR
LF	<input type="text"/>		<input type="text"/>	RF

LR	<input type="text"/>	TOTAL	<input type="text"/>	RR
LF	<input type="text"/>		<input type="text"/>	RF

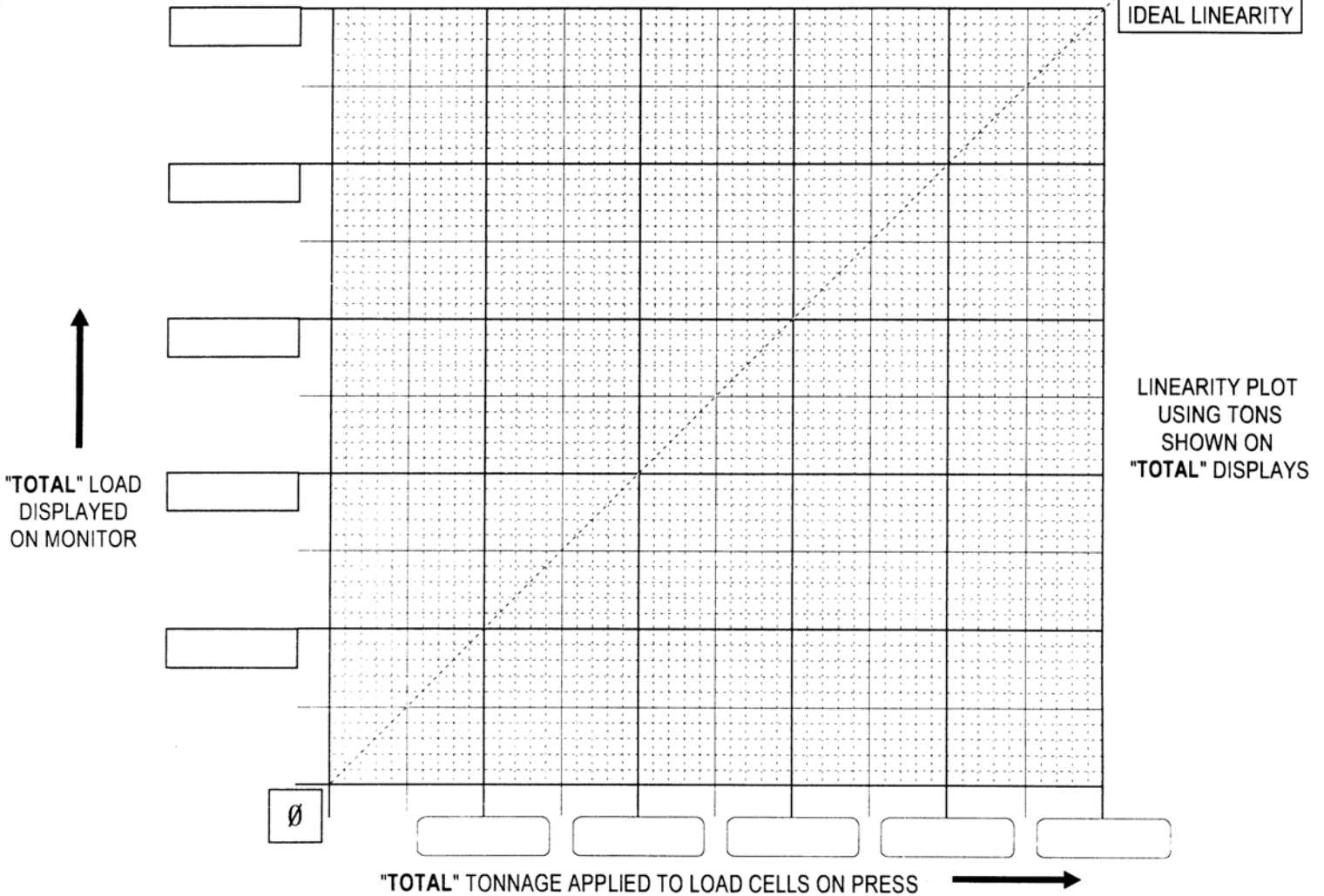

- DRAW IN :** \_\_\_\_\_
- CHANNEL NUMBER
  - SENSOR LOCATION
  - MONITOR LOCATION
  - LOAD CELL LOCATION
  - DIRECTION OF MATL. FLOW

**SHUNT RESISTORS:**  
ONE MEG ? YES \_\_\_ NO \_\_\_

**OTHER RESISTORS:**

CHAN. 1 \_\_\_\_\_

CHAN. 2 \_\_\_\_\_

CHAN. 3 \_\_\_\_\_

CHAN. 4 \_\_\_\_\_

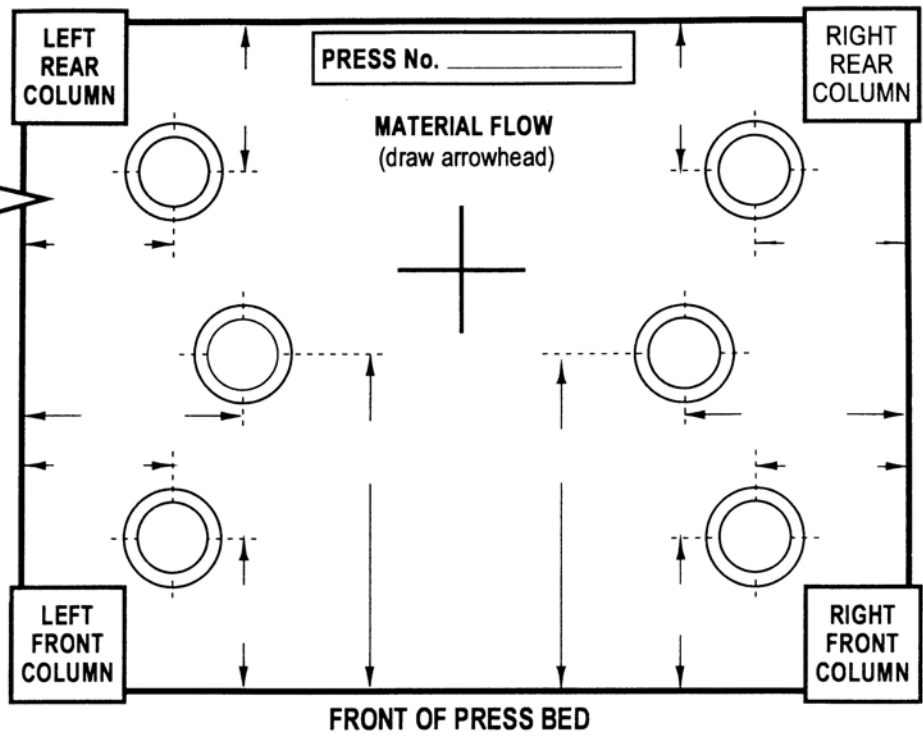

TYPE OF LOAD CELLS: \_\_\_\_\_ TYPE OF LOAD CELL READOUT: \_\_\_\_\_

**TONNAGE SENSORS**

**CALIBRATION LOAD CELLS**

SENSOR NUMBER	SERIAL NO.	CAL. NO.	X 10	LOCATION (LF, RF, LR, RR)
1				
2				
3				
4				

CELL NUMBER	CAPACITY TONS	SERIAL NO.	CAL. NO.
1			
2			
3			
4			

CCM TYPE: \_\_\_\_\_ CCM OFFSET: \_\_\_\_\_ STI REFERENCE NUMBER: LOW: \_\_\_\_\_ HIGH: \_\_\_\_\_

STI DEGREES IN CHANNEL No. 1: \_\_\_\_\_

TRIGGERED FROM PROBE ? YES \_\_\_ NO \_\_\_ (Show threshold value if not triggered from probe): \_\_\_\_\_

TRIPPED ALARM RELAY STOPS PRESS ? YES \_\_\_ NO \_\_\_ EXPLAIN: \_\_\_\_\_

ALL STICKERS AND DOCUMENTS FILLED OUT ? YES \_\_\_ NO \_\_\_ IF NOT, EXPLAIN WHY: \_\_\_\_\_

TFP No.: HIGH 2 \_\_\_\_\_ LOW 2 \_\_\_\_\_ HIGH 4 \_\_\_\_\_ LOW 4 \_\_\_\_\_ HIGH 6 \_\_\_\_\_ LOW 6 \_\_\_\_\_ HIGH 8 \_\_\_\_\_ LOW 8 \_\_\_\_\_

COMMENTS: \_\_\_\_\_

\_\_\_\_\_

\_\_\_\_\_

TESTS MADE BY: \_\_\_\_\_ TESTS ACCEPTED BY: \_\_\_\_\_ DATE: \_\_\_\_\_

**MAIL ADDRESS:**  
TOLEDO TRANSDUCERS, INC.  
P.O. BOX 10  
HOLLAND, OHIO 43528

**SHIPPING ADDRESS:**  
TOLEDO TRANSDUCERS, INC.  
6834 SPRING VALLEY DR.  
HOLLAND, OHIO 43528

**PHONE:** 1 (419) 867-4170  
**FAX:** 1 (419) 867-4180

COMPANY: \_\_\_\_\_

DATE: \_\_\_\_\_

\_\_\_\_\_  
\_\_\_\_\_

PRESS SERIAL No: \_\_\_\_\_

PRESS (Type and & No.): \_\_\_\_\_

CONTACT: \_\_\_\_\_

PRESS CAPACITY: \_\_\_\_\_

PHONE: (\_\_\_\_) \_\_\_\_\_

LOAD MONITOR MODEL: \_\_\_\_\_

SERVICE ORDER #: \_\_\_\_\_

MONITOR SERIAL No. \_\_\_\_\_

SLIDE-ADJUST INDICATOR

TONNAGE APPLIED TO **LOAD CELLS** ON PRESS

TONNAGE DISPLAYED ON **LOAD MONITOR**

LR	<input type="text"/>	TOTAL	<input type="text"/>	RR
LF	<input type="text"/>	<input type="text"/>	<input type="text"/>	RF

LR	<input type="text"/>	TOTAL	<input type="text"/>	RR
LF	<input type="text"/>	<input type="text"/>	<input type="text"/>	RF

LR	<input type="text"/>	TOTAL	<input type="text"/>	RR
LF	<input type="text"/>	<input type="text"/>	<input type="text"/>	RF

LR	<input type="text"/>	TOTAL	<input type="text"/>	RR
LF	<input type="text"/>	<input type="text"/>	<input type="text"/>	RF

LR	<input type="text"/>	TOTAL	<input type="text"/>	RR
LF	<input type="text"/>	<input type="text"/>	<input type="text"/>	RF

LR	<input type="text"/>	TOTAL	<input type="text"/>	RR
LF	<input type="text"/>	<input type="text"/>	<input type="text"/>	RF

LR	<input type="text"/>	TOTAL	<input type="text"/>	RR
LF	<input type="text"/>	<input type="text"/>	<input type="text"/>	RF

LR	<input type="text"/>	TOTAL	<input type="text"/>	RR
LF	<input type="text"/>	<input type="text"/>	<input type="text"/>	RF

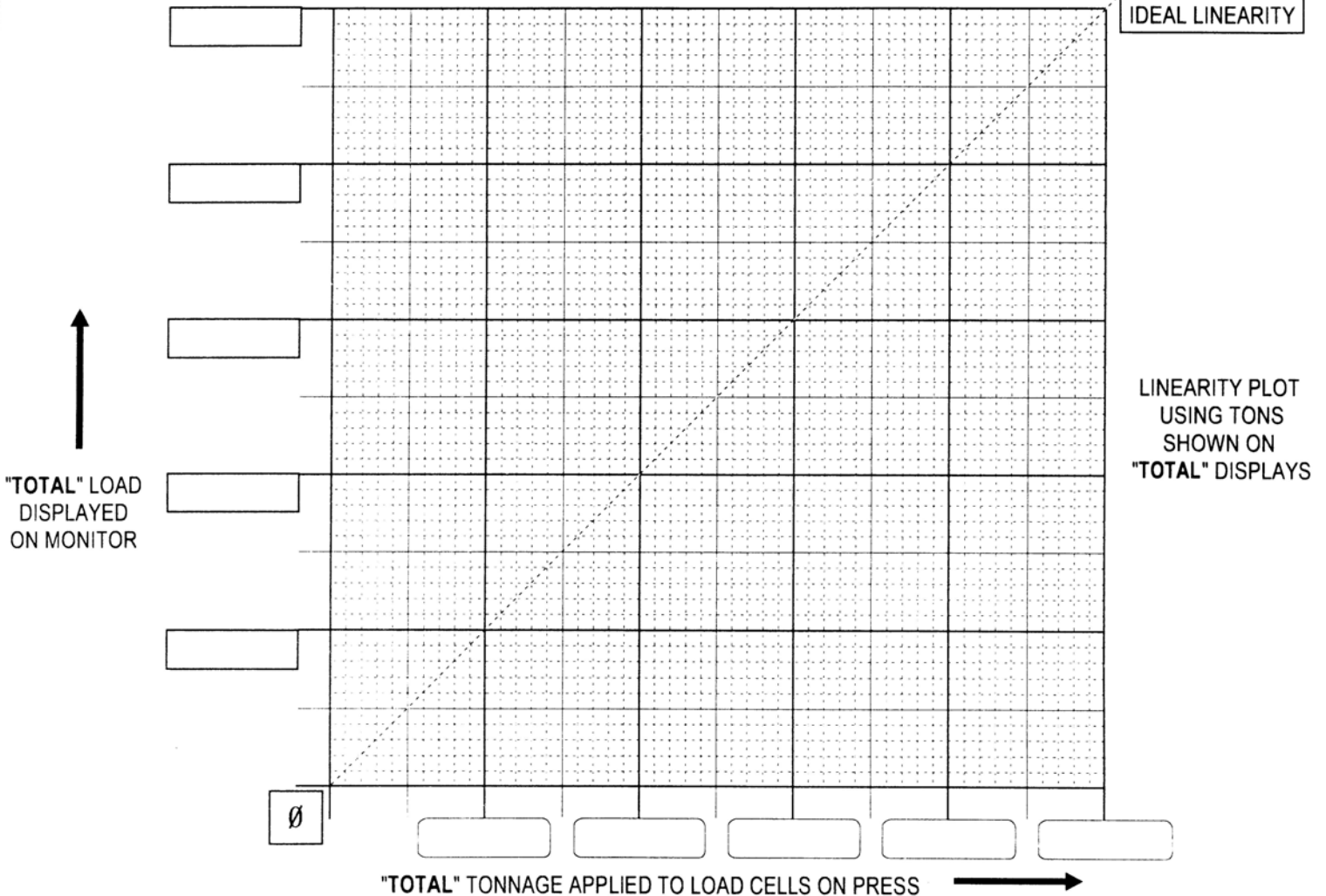

- DRAW IN :** \_\_\_\_\_
- CHANNEL NUMBER
  - SENSOR LOCATION
  - MONITOR LOCATION
  - LOAD CELL LOCATION
  - DIRECTION OF MATL. FLOW

**SHUNT RESISTORS:**  
ONE MEG ? YES \_\_\_ NO \_\_\_

**OTHER RESISTORS:**

CHAN. 1 \_\_\_\_\_

CHAN. 2 \_\_\_\_\_

CHAN. 3 \_\_\_\_\_

CHAN. 4 \_\_\_\_\_

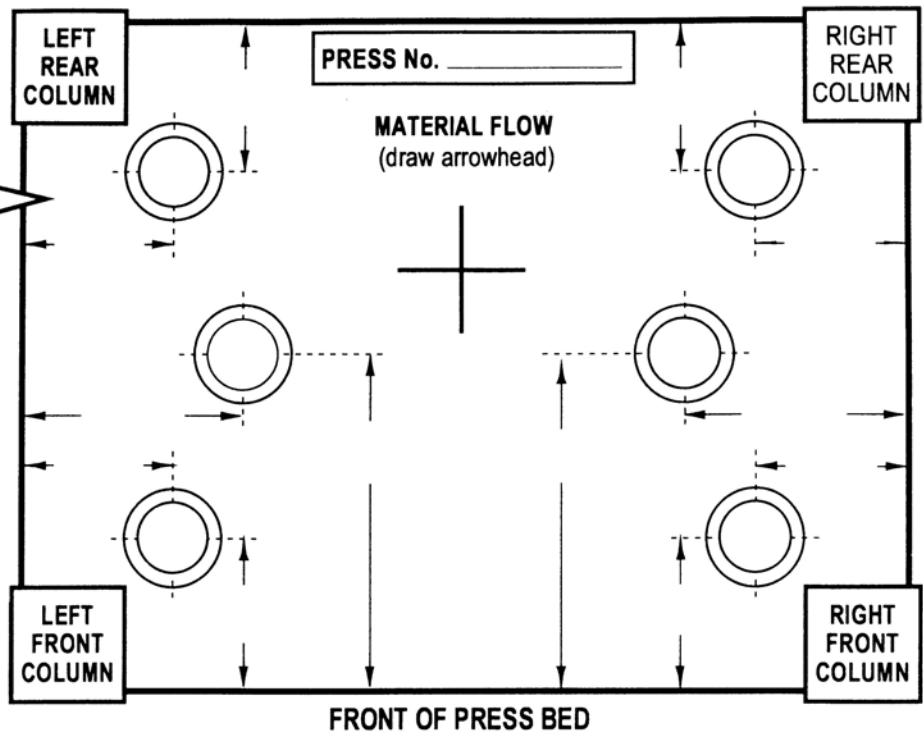

TYPE OF LOAD CELLS: \_\_\_\_\_

TYPE OF LOAD CELL READOUT: \_\_\_\_\_

**TONNAGE SENSORS**

**CALIBRATION LOAD CELLS**

SENSOR NUMBER	SERIAL NO.	CAL. NO.	X 10	LOCATION (LF, RF, LR, RR)
1				
2				
3				
4				

CELL NUMBER	CAPACITY TONS	SERIAL NO.	CAL. NO.
1			
2			
3			
4			

CCM TYPE: \_\_\_\_\_ CCM OFFSET: \_\_\_\_\_ STI REFERENCE NUMBER: LOW: \_\_\_\_\_ HIGH: \_\_\_\_\_

STI DEGREES IN CHANNEL No. 1: \_\_\_\_\_

TRIGGERED FROM PROBE ? YES \_\_\_ NO \_\_\_ (Show threshold value if not triggered from probe): \_\_\_\_\_

TRIPPED ALARM RELAY STOPS PRESS ? YES \_\_\_ NO \_\_\_ EXPLAIN: \_\_\_\_\_

ALL STICKERS AND DOCUMENTS FILLED OUT ? YES \_\_\_ NO \_\_\_ IF NOT, EXPLAIN WHY: \_\_\_\_\_

TFP No.: HIGH 2 \_\_\_\_\_ LOW 2 \_\_\_\_\_ HIGH 4 \_\_\_\_\_ LOW 4 \_\_\_\_\_ HIGH 6 \_\_\_\_\_ LOW 6 \_\_\_\_\_ HIGH 8 \_\_\_\_\_ LOW 8 \_\_\_\_\_

COMMENTS: \_\_\_\_\_

\_\_\_\_\_

\_\_\_\_\_

TESTS MADE BY: \_\_\_\_\_ TESTS ACCEPTED BY: \_\_\_\_\_ DATE: \_\_\_\_\_

**MAIL ADDRESS:**  
TOLEDO TRANSDUCERS, INC.  
P.O. BOX 10  
HOLLAND, OHIO 43528

**SHIPPING ADDRESS:**  
TOLEDO TRANSDUCERS, INC.  
6834 SPRING VALLEY DR.  
HOLLAND, OHIO 43528

**PHONE:** 1 (419) 867-4170  
**FAX:** 1 (419) 867-4180