

Operating Instructions

DIE-TRY

with

AUTO CAL

and

AT Automatic Target alarms

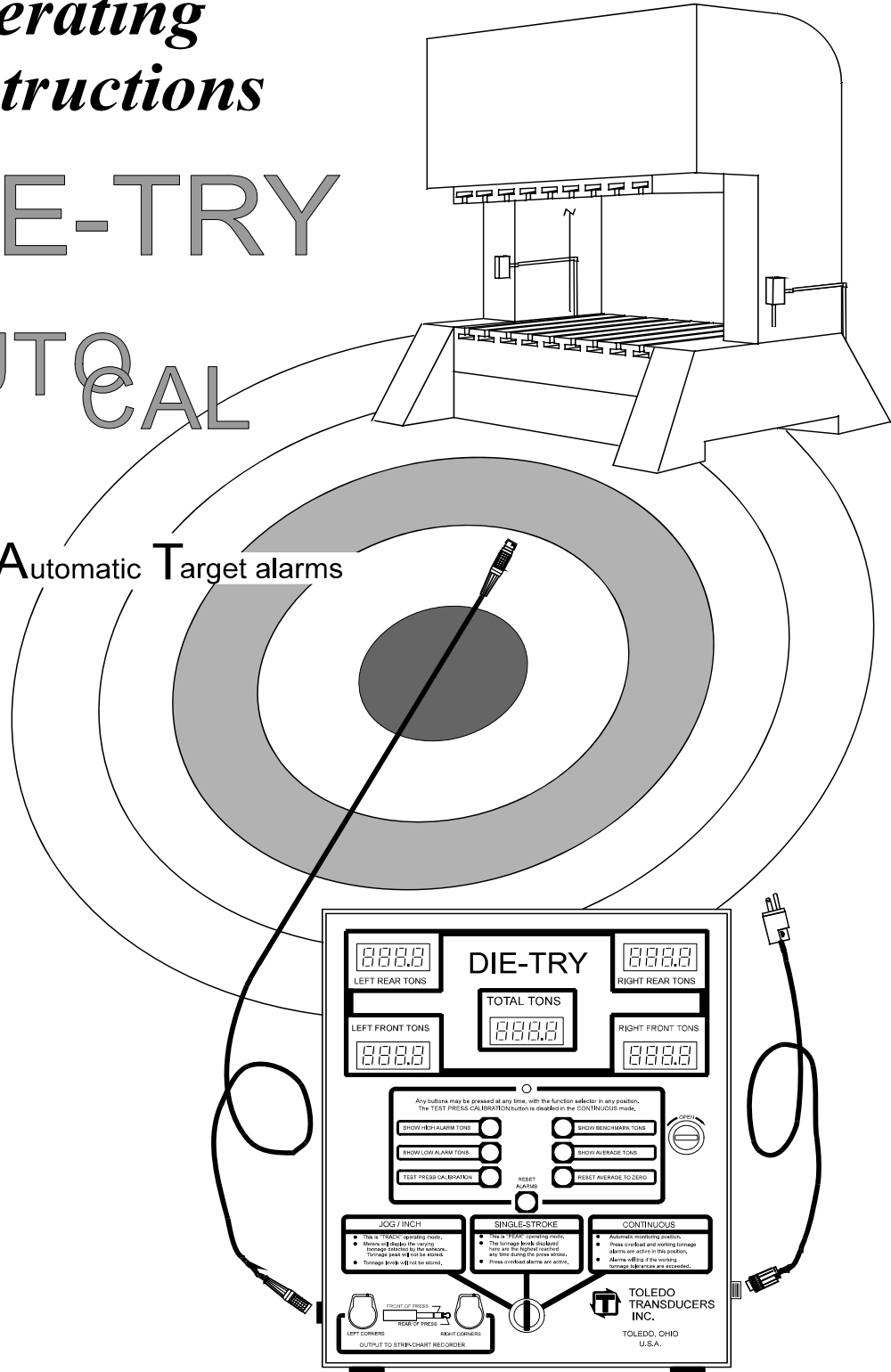

TOLEDO TRANSDUCERS, INC.
Phone: (419) 867-4170



HOLLAND, OHIO U.S.A.
Fax: (419) 867-4180

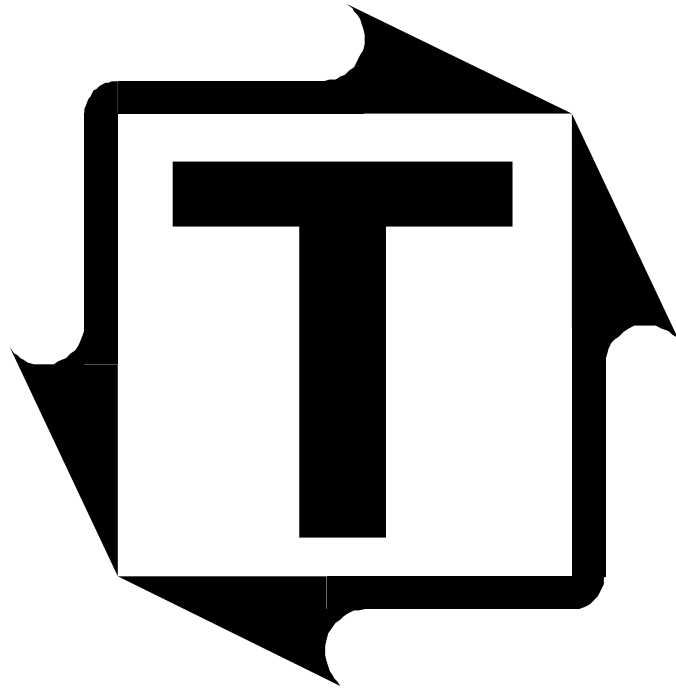

DIE-TRY

Operating Instructions

Revision: B



Scan to visit us
on the web

CONTENTS

How Tonnage Systems Work

Introduction	3
Tonnage Instruments	3
Load Monitors	3
Production Monitors.....	3
Portable Tonnage Meters.....	4
Portable Tonnage Meters Are Important	4
About Press Calibration.....	4
Determining Calibration (CAL) Numbers.....	5
The Importance of AUTO-CAL.....	5
Entering Numbers Into AUTO-CAL Memory	6
The Value of DIE-TRY with AUTO-CAL.....	6
The DIE-TRY as A Portable Load Monitor	
Benchmark Monitoring with AT (Automatic Target) Alarms	8
DIE-TRY Operating Modes	8
Record Tonnage Changes on Graphs	9
Operating the DIE-TRY Series Instrument	
Introduction	9
The DIE-TRY Instrument	11
Operator Controls.....	11
Function Selector.....	11
Single-stroke Mode:	12
Continuous mode:.....	12
Jog/inch Mode:.....	12
Upper And Lower Alarm Controls.....	12
Supervisor Controls.....	12
Using The DIE-TRY Instrument for Monitoring Production	13
To Check Instrument Calibration	13
A Quick Calibration test.....	14
To Re-set Tripped Alarms.....	14
About Benchmark Monitoring And AT Alarms	
Introduction.....	15
Alarm Levels.....	15
Without AT (Automatic Target) Alarm-set	15
With AT (Automatic Target) Alarm-set	16
Choosing AT Alarm Levels.....	16
Decisions.....	16
Digital Displays On The Front Panel	17
The Function Selector	17
Single-stroke Mode	17
Continuous Automatic Monitoring.....	17
Jog/inch Mode	17
Front Panel Pushbuttons.....	18
Test Press Calibration.....	18
Show High Alarm Limits	18
Show Low Alarm Limits.....	18
Show Benchmark Tons	18
Show Average Tons	18
Reset Average To Zero.....	18
Alarm Reset Button	18
To Show Maximum-tonnage (Capacity) Alarm Trip Points	18
Analytical Signal Outputs	19
Features Inside The Enclosure	
Electrical Safety	19
Supervisor Controls.....	19
Upper And Lower Alarm Controls.....	19
To Store Calibration Numbers With AUTO-CAL	19
To Recall A Calibration	20
Selecting Instrument And Accessories	
Two Standard Sensor Packages.....	22
For Press Control.....	22
For Press Calibration.....	23
Appendix A.....	27

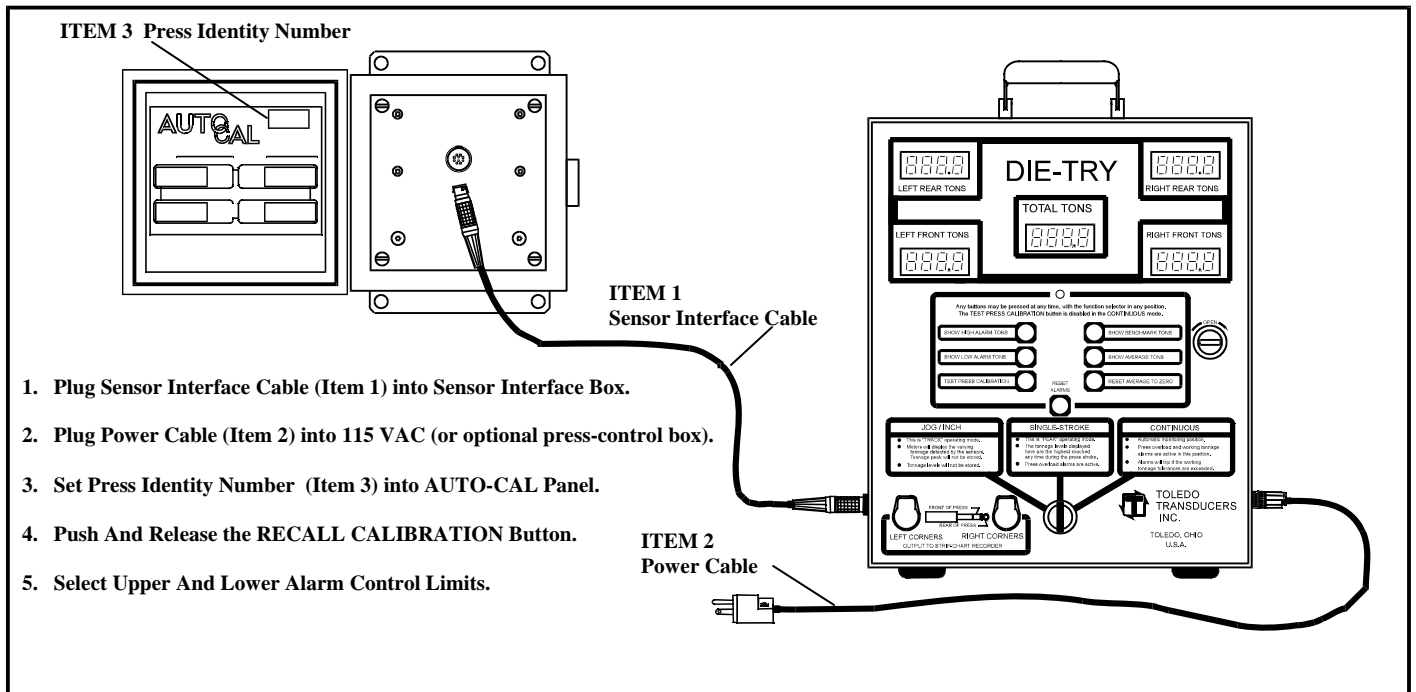

AUTO-CAL

TO RECALL CALIBRATION

1. Set press identity number.
2. Push RECALL button.

TO STORE CALIBRATION

1. Set press identity number.
2. Set press capacity in tons.
3. Push CAPACITY button.
4. Set CAL. no. for Left Rear sensor.
5. Push Left Rear sensor button (LR).
6. Repeat steps 4 & 5 for RR, LF, RF.

SET CAL. NUMBERS AND TONS HERE

PRESS IDENTITY NO.

RECALL CALIB.

CAPACITY

LR <input type="radio"/>	RR <input type="radio"/>
LF <input type="radio"/>	RF <input type="radio"/>

TO SET UPPER ALARM CONTROL LIMITS

HIGH AND LOW ALARM CONTROLS

TO SET LOWER ALARM CONTROL LIMITS

AUTO-CAL AND AUTOMATIC TARGET ALARMS PANEL INSIDE THE DIE-TRY

HOW TONNAGE SYSTEMS WORK

INTRODUCTION

We urge you to read this section unless you are familiar with tonnage measurement systems. This section is important for understanding the value of tonnage meters and AUTO-CAL memory. You should know how AUTO-CAL based instruments have advanced the state-of-the-art.

A tonnage measurement system is composed of one or more sensors plus an instrument. Each sensor needs one channel of instrumentation.

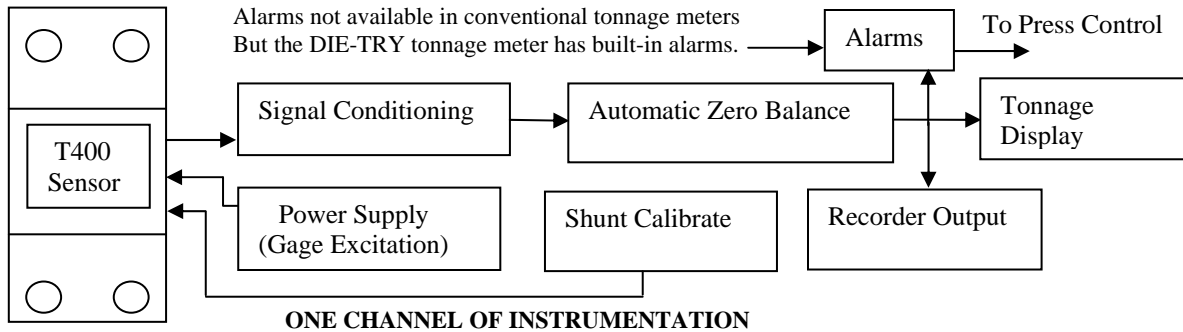

A C-frame press uses two sensors so therefore needs a two-channel instrument. A four-column press uses one sensor on each press corner so a four-channel instrument is needed for a straight side press. Some monitor companies install two-channel instruments on four-column presses. This is cheaper so it often looks good on a budget request. However, it usually prevents a customer from gathering of good die and product information. Tonnage sensors sometimes are mounted to holes drilled in the press frame at strategic locations. These locations are usually the places the press frame stretches or compresses the most as it does work.

The most popular mounting method is to weld pre-drilled steel pads at the strategic locations. The press frame stretches as it exerts force. This causes the distance to change between the sensor mounting holes. This dimensional change is what a tonnage sensor detects. Think of a tonnage system as a high-speed electronic micrometer. What the sensors detect is the strain level (dimensional change) between the sensor mounting holes. Higher strain levels cause higher sensor output. Sensors that are mounted to the frame are not calibrated to a known tonnage standard. However, they are designed, manufactured and tested to be as similar as possible. This assures that you can replace the sensors and the instrument without re-calibrating the system. If you now have our competitor's sensors mounted to your presses we usually can use them. However, in some cases, press re-calibration is necessary.

TONNAGE INSTRUMENTS

Tonnage instruments can be divided into three broad categories:

1) LOAD MONITORS

These instruments are for press and tooling overload protection. Our series N400 instruments are typical load monitors. Built-in alarms stop the press when trouble develops. Suppose your plant has a history of press and tooling damage. You can mount relatively inexpensive basic load monitors on your presses. Then set the built-in alarms so they will trip when the tonnage reaches the capacity of the press.

If press overload is the major problem, the alarms need not be changed once they are adjusted. You could use a simple load monitor for product protection. That means the alarms could be set to trip slightly above the working tonnage. The alarm trip points must be changed every time the forming tonnage is changed. The alarm trip points of basic monitors are usually tedious to adjust. They must be adjusted regularly by someone who can make important decisions. Each alarm for each channel must be adjusted every time a new job is set up. That is at least 8 critical adjustments per job.

2) PRODUCTION MONITORS

These are sophisticated load monitors. Our PRESSWATCH series monitors are excellent production monitors.

Production monitors provide the same die and press protection as a load monitor. Built-in alarms stop the press when trouble develops. Alarm trip points are very easy to change. Our production monitors work on percent-of-tonnage-change. In many cases it is not necessary to change the alarm setpoints from job to job.

Suppose that you want to protect the press and tooling but you also want to control the quality level of the formed product. In that case you need a more sophisticated instrument than a basic load monitor. The difference between a conventional load monitor and a production monitor is the ease with which the alarms are adjusted from job to job. Production monitors also often have circuits that communicate with computers.

3) PORTABLE TONNAGE METERS

Portable meters are used by technically oriented people for press and tooling analysis, press set-up and press calibration. Conventional portable tonnage meters are usually not used for load monitoring because they do not have built in alarms.

PORTABLE TONNAGE METERS ARE IMPORTANT

Most customers don't have tonnage instruments on all their presses. That could require a big budget. Many presses do mundane non-critical jobs so load monitors might not be cost-effective. However, die change over can be made more efficient when form tonnage measurement is used. That is where portable tonnage meters are important. Until now, portable tonnage meters usually were mainly for press calibration or press and tooling analysis. The instruments would accept the output signals from either press-mounted sensors or load cells. Unfortunately, conventional tonnage meters are difficult to use because they have many controls that must be adjusted frequently. To adjust a common tonnage meter for a four-column press takes about 28 separate steps. With our DIE-TRY portable meter you turn only two switches and push one button when you move from press to press.

Portable tonnage meters usually don't have built-in alarms. Old style portables are for press analysis and calibration by technically oriented people with plenty of time and training. Some load monitor companies merely add a handle and an AC cord to their standard load monitor (with built-in alarms). Then they can sell it as a "portable". True, the instrument is movable but it certainly doesn't correct the problem of needing over 28 steps per set-up. There are many chances for mistakes performing all of those steps.

Our DIE-TRY instruments with AUTO-CAL memory are sophisticated and versatile portable tonnage meters that are simple to use. In addition, they have built-in alarms for press and tooling protection. AUTO-CAL memory can remember the calibration for as many as 100 separate presses. Because of AUTO-CAL memory, it is easy to move the DIE-TRY to a variety of straight-side and C-frame presses.

It takes lots of effort and time to move a common portable load monitor from press to press. You can figure at least 28 steps for "movable" load monitor. You need at least 36 steps to use a calibration meter the first time. Add another 5 steps each time you want to read the tonnage. With a DIE-TRY monitor, it's just a matter of turning two switches and pushing a RECALL button. The DIE-TRY instrument has a display that continuously shows the tonnage on each corner of the press and the total tonnage.

ABOUT PRESS CALIBRATION

Although press calibration is usually the term used, system calibration is actually what is being done. The distance changes between the sensor mounting holes as the press does work. There is no way to predict the strain levels at the sensor mounting location. The popular way to calibrate a tonnage system is to force the press to do a specific amount of work. The stain level at each sensor location can then be measured.

System calibration usually requires two instruments:

- 1) The instrument to be adjusted
- 2) A portable calibration instrument

The instrument being adjusted is connected to the frame-mounted sensors. The calibration instrument is connected to calibrated load cells. Their accuracy is traceable to the National Bureau of standards. These load cells are placed in the press bed area. The press is then cycled to impact on the cells. The calibration instrument displays the tonnage exerted by the press. Shut height is then adjusted until the press is working at its rated tonnage level. The instrument to be calibrated is then adjusted to display the same tonnage as the calibration

instrument. Suppose you are calibrating a 100-ton straight side press. You would adjust the shut-height until the ram hits the cells with 100 tons of force. The portable calibration meter would display this 100 tons of force. The un-calibrated instrument is then adjusted until it also displays 100 tons. Calibration is complete when the tonnage displayed by the adjusted instrument agrees with the calibration meter. The last step is to calculate what we call CAL numbers.

DETERMINING CALIBRATION (CAL) NUMBERS

A tonnage measurement system is usually calibrated. Re-calibration is rarely needed if the instrument or sensors are changed. A tonnage instrument is actually measuring press stretch per ton at the sensor location. The strain-versus-tonnage level at a specific location on a press usually doesn't change unless the press frame is modified or the tie-rods are tightened.

There are two main ways to get a usable signal from a tonnage sensor. One way is to physically distort the sensor body by making it measure strain. The other way is to unbalance it electrically by applying a simulated load to the sensors. This technique is called "shunt calibration." A precision electrical resistance is built into each channel of the DIE-TRY tonnage monitor. This resistance is called a shunt because it is applied across the sensor circuit. Shunt resistance is applied to each sensor while they are not under mechanical strain. This causes the sensor to react electronically as if a true strain level was applied to it. A tonnage signal will be developed and displayed by the newly calibrated instrument.

The number displayed by each instrument channel is recorded as the CAL number for that channel. The CAL number represents the gain level of the amplifier in each sensor channel. Suppose a sensor or instrument is replaced. The system can easily be re-calibrated. Merely press the TEST CALIBRATION button and adjust the instrument to the proper CAL number.

IMPORTANCE OF AUTO-CAL

AUTO-CAL provides a much-needed new type of memory management for tonnage instruments. This is probably the most important feature any load monitor company has developed in many years. We now make a practical portable tonnage meter that is extremely easy to use. We have made portable tonnage meters for years. Until now, it took at least 28 steps to set up any portable instrument when you moved it from one straight side press to another one. AUTO-CAL changed all that. Now it takes just three steps to change from press to press:

1. Plug the monitor into a sensor box on the press.
2. Enter a 2-digit press-identity number into the instrument.
3. Push a RECALL CALIBRATION button.

We offer AUTO-CAL circuits in our DIE-TRY instrument for die setters, die makers and others who work directly with dies and tooling. There are special features that are important for die change over and die checking during building or repair. This new meter represents new ideas in tonnage instrument memory management. DIE-TRY offers the stamping industry an impressive way to improve press operations at a reasonable cost.

Suppose someone tells you they can mount a handle on a regular load monitor so you can carry it from press to press. Each time you moved that monitor to a press you would need to perform about 28 set-up steps (or more). Suppose you want to move a standard tonnage monitor from one press to another four-column press. The following list shows the steps that must be performed before you can use a conventional tonnage meter.

- Step 1 Apply shunt to sensors.
- Step 2 Turn automatic zero balance off.
- Step 3 Put instrument in track mode.
- Step 4 Select channel #1 for adjustment and display.
- Step 5 Adjust channel #1 zero balance control for display zero.
- Step 6 Adjust channel #1 span control for CAL number.
- Repeat steps 4, 5 and 6 for channels #2, #3 and #4.
- Step 26 Turn automatic zero balance on.
- Step 27 Put instrument back in peak mode.
- Step 28 Remove shunt resistance from sensor.

We often say there are more than 28 steps needed to adjust a monitor from press to press. It is a rare technician that will only use 2 steps to adjust the zero balance and span (gain) controls. Usually this is a seesaw operation that can be time consuming. Automatic AUTO-CAL memory circuits shrink the above list down to only two simple steps . . . Enter the press ID number into the instrument then push one button.

ENTERING NUMBERS INTO AUTO-CAL MEMORY

The DIE-TRY has an AUTO-CAL control panel located inside the instrument. The panel is divided into two sections. The top section is used when the DIE-TRY is moved from press to press. The only time the bottom section will be used is when adding new CAL numbers into memory. Locate DIP-switch 8 at the edge of the supervisor’s panel. Put it to ON. *For presses with capacities less than 400 tons, read appendix A before proceeding to the steps listed below.*

1) Suppose you have 800 ton press what was previously calibrated. The bottom section of the AUTO-CAL panel will be used to “introduce” the meter to the press. The first thing to do is pick a two-digit Press Identity number. It may be anything from 00 through 99. Suppose this is the first press you have done. A logical number would be 01. Set the first PRESS IDENTITY selector to zero. Set the second selector to position one.

2) In this example the rated press capacity is 800 tons so set the bottom four selectors to 0 8 0 0. Press and release the CAPACITY button.

3) Suppose the CAL number of the left rear press corner is 87. Set the bottom selectors to 0 0 8 7. Press and release the LR button.

4) Suppose the CAL number for the right rear press corner is 92. Set the bottom selectors to 0 0 9 2. Press and release the RR button.

5) Suppose the CAL number of the left front press corner is 103. Set the bottom selectors to 0 1 0 3. Press and release LF button.

6) Suppose the CAL number for the right front press corner is 75. Set the bottom selectors to 0 0 7 5. Press and release RF button.

7) Press and release the RECALL CALIBRATION button.

Return DIP-switch 8 to OFF. CAL number entry is now complete for this press example. You shouldn’t need to repeat these steps for this press identity number again unless the CAL numbers change for some reason.

THE VALUE OF DIE-TRY WITH AUTO-CAL

The DIE-TRY is the first instrument to have our exclusive AUTO-CAL portability circuits built in. It is a tonnage meter that was designed to be an important tool for the engineering and technical departments, the die-setters and the die makers. The DIE-TRY was designed primarily for people that are indirectly connected with parts production. The DIE-TRY is also a full-feature load monitor so it can also be used for monitoring productions.

The budgets of many small stamping plants don’t allow for mounting tonnage systems on every press. Press down time will be reduced when a tonnage meter is used during setup. Die change over will be faster and safer. Stamping problems can be solved quicker. Die life will be extended. Presses can be overworked when necessary with a great deal more safety. You won’t need to accept the die maker’s word that dies work to specifications. Production will be speeded up. Scrap will be reduced. The list goes on . . .

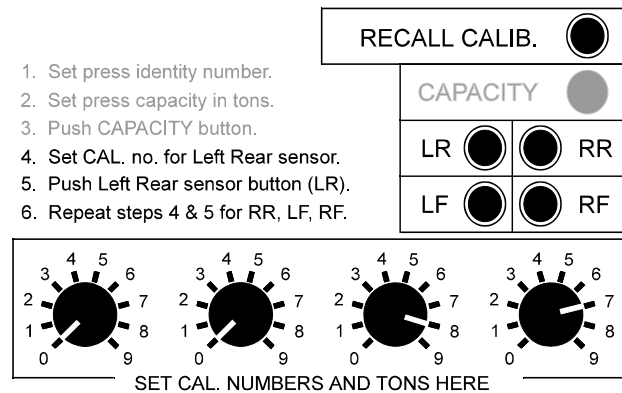
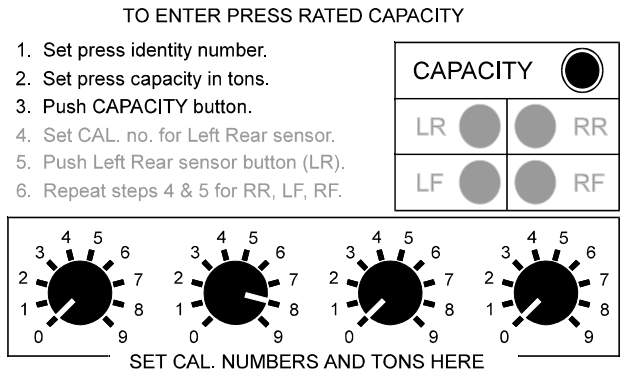

Occasionally a particular job is critical. You will save yourself many problems if you monitor the job with a tonnage instrument. A DIE-TRY portable can quickly be moved to the press running the job instead of putting the job in a press with a built-in monitor. Perhaps it is necessary sometimes to run a job in a press that is too small. If you must exceed the rated capacity of the press a DIE-TRY will make certain you know the precise amount of overload. Perhaps you regularly under-work your presses without knowing it. That is not efficient. Setting up a job with a portable load monitor can quickly show how well a press is being utilized.

How can you get these benefits without a large expense? Mount sensors on all presses and carry a portable DIE-TRY from press to press. If you can't put sensors on all presses, at least put them on your important presses. As you get comfortable with portable monitoring you can add sensors to your other presses.

Stamping plant managers are demanding faster and faster die change over and less press downtime. Your DIE-TRY instrument is designed specifically to make change over faster and much safer. Suppose the die made a good part at 94 tons the last time it was used. It is fairly simple too safely and quickly adjust the press to work at 94 tons again. This should assure a good part is again being made. In theory that is correct but in practice the actual tonnage could be higher or lower if the die set was reworked after it was last used. Improperly reworked tooling is a fact of life. With DIE-TRY, the die setter will notice the problem before he wastes time or damages the tooling.

Die designers and die makers will find the DIE-TRY extremely valuable for determining average tonnage levels. The average press tonnage during a series of press strokes may be displayed by merely pushing one button. This is much easier than trying to read the tonnage on four-corners of the press as parts are quickly formed. Average total tonnage is also displayed.

A sophisticated die maker or re-builder can plug a strip chart recorder into the DIE-TRY. The detailed tonnage waveshape can be recorded graphically. This process can help avoid arguments when dies are delivered to the customer. We see an increasing number of die buyers requiring more detailed tonnage proof that a die is functioning properly. The DIE-TRY instrument offers important features for solving forming problems. A simple strip chart recorder can easily show and help correct some tricky problems. You can see such things as excessive snap through, poor stagger of punches, improper stripper action, unbalanced nitrogen spring units and much more. Often a part can be formed at higher speeds by checking the instrument while making minor adjustments to the die or tooling. Poor selection, adjustment or positioning of stop blocks can easily be identified with a DIE-TRY instrument.

If necessary, DIE-TRY instruments may be used to monitor parts-production after press setup is completed. We have noticed during the last years that die-setters have been pushing hard for their companies to install tonnage instruments. The DIE-TRY instrument was developed specifically for the skilled tradesman that either does press setups or works with dies. The DIE-TRY is not a common load monitor even though it has built-in alarms and a "learn" mode. The front panel and inside controls are laid out specifically for press setup.

The die setter or die-maker can carry a DIE-TRY to the press, perform his job then take the DIE-TRY to the next press. In the ideal shop, each die setter would have his own DIE-TRY instrument. The DIE-TRY will make the die setter far more efficient. He can do a press setup quicker and with more accuracy. A die setter will quickly learn to spot press problems that effect the quality of the formed parts. Most die setters are very conscientious. If they spot a potential problem they usually notify the press maintenance people. The DIE-TRY therefore provides an excellent early-warning system.

Many shops have some older presses that are not consistent from hit to hit. That makes it difficult for a die setter to decide exactly what tonnage the press is set up for. The DIE-TRY may be plugged into a press at any time to check the average forming tonnage. The average forming tonnage of any number of hits can be recalled by pushing one button. Another button resets the average tonnage to zero. These two buttons can be important tools when working with unstable presses. A typical tonnage can be recorded so it may be checked periodically.

For example, the average forming tonnage may be recorded before the die setter pulls the tooling from the press. This will show whether the die needs work done to it. Recording the average tonnage will also make press setup faster the next time the die is used.

THE DIE-TRY AS A PORTABLE LOAD MONITOR

BENCHMARK (Automatic Target) ALARMS

When we refer to a system as being calibrated it means the press is loaded by impacting on load cells that have been calibrated on test equipment that is traceable to the National Bureau Of Standards.

There are times when press tonnage is very important. For example, during press setup, when checking die-forming tonnage, when recording tonnage for future reference, and so on. However, actual tonnage loses much of its importance when the press begins to make parts. Tonnage stability then becomes vital. Any deviation in forming tonnage represents a change in the formed part. If the forming tonnage varies too much the part quality will suffer.

FOR EXAMPLE:

QUESTION (A) . . A press is making parts at 120 tons. Are those parts good or bad?

QUESTION (B) . . The forming tonnage has increased by 35% since the job was set up. Do you think you should stop the press to check what has happened?

As you can see, a decision is impossible in test A. You need more information, such as the initial press setup tonnage. In test B you don't need to know what the initial setup was. In this example, all you need to decide is whether a 35% tonnage change is a sign that something is wrong.

You could easily decide how much variation in forming tonnage you can stand before a bad part is made. All you need to do is change two switches inside the DIE-TRY meter. One switch selects the percentage of tonnage increase that can be tolerated. The other switch selects the minimum level the tonnage must reach. These switches are part of the **AT** (Automatic Target) circuits. The meter will remember the initial setup tonnage when you put the instrument into the CONTINUOUS monitoring mode. Excess deviation in forming tonnage will trip one of the alarms.

The DIE-TRY may be used to monitor press production. It has a "learn" mode and controls for setting UPPER and LOWER alarm limits. These controls are the same as on our standard PW4 and PW2 PRESSWATCH tonnage monitors. The alarm controls of the DIE-TRY perhaps will not be used often if your DIE-TRY is primarily for press setup. However, some die makers run parts to prove to a customer that the die is OK. Therefore, the DIE-TRY may be used for monitoring parts production.

DIE-TRY OPERATING MODES

The DIE-TRY has three operating modes controlled by a function switch on the front panel.

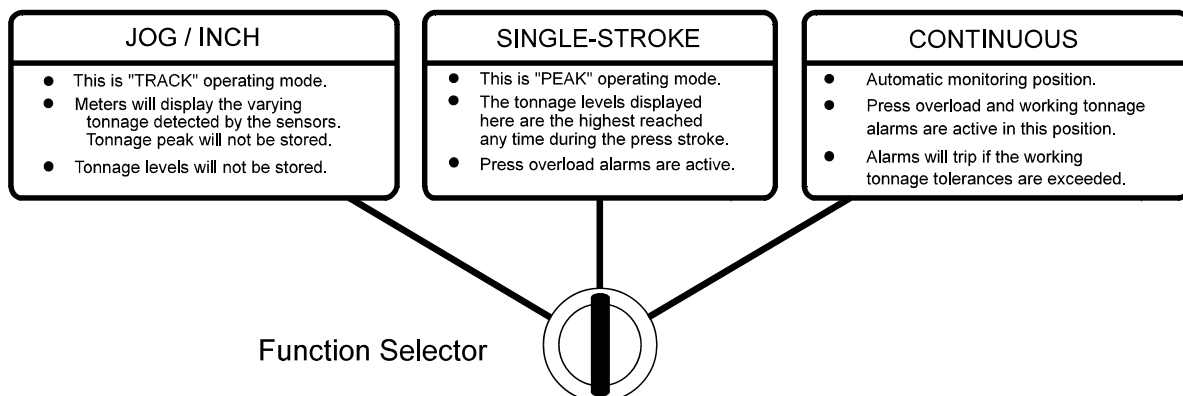

In the operating mode called SINGLE STROKE the DIE-TRY displays only the peak tonnage that was reached during the press stroke. This is the normal operating mode for press setup. Forming tonnage alarms are disabled in this switch position. Press overload (capacity) alarms are armed and active in the SINGLE STROKE mode.

NOTE . . It would be hardship for the die setter if **AT** forming-tonnage alarms were active while he or she was adjusting a press. Low-level forming tonnage alarms would be tripping. The die setter would frequently need to reset tripped alarms.

The mode called JOG/INCH allows the operator to see the changing tonnage as the press moves through a slow cycle. The peak tonnage is not stored. Only the press overload alarms are armed and active in this operating mode. On a conventional load monitor, only the peak tonnage is displayed after the press stroke is completed. The DIE-TRY meter is used for press setup so it is often important to see the changing (track) tonnage as the part is being formed. This helps the die-setter to stagger punches, check stop blocks, check stripper action, check die cushions and so on. It usually takes a lot of effort to set up a conventional load monitor so it can display the “track” signal. All the die setter needs to do with the DIE-TRY is to turn one switch. I assure you, this is a very practical, valuable and unique function.

The operating mode CONTINUOUS is the automatic tonnage-monitoring mode. In this mode all alarms are armed and active. An alarm will trip if the working tonnage goes outside a pre-selected working band. The DIE-TRY automatically learns the working tonnage levels. It then automatically sets the appropriate alarm trip points. Press-overload alarms are armed and active in this mode. You have immediate first-hit protection for product, die and press when entering the CONTINUOUS (learn) mode.

RECORD TONNAGE CHANGES ON GRAPHS

One of the most powerful features of the DIE-TRY instrument is the ability to make strip chart recordings of tonnage changes. A strip chart recorder or oscilloscope may be plugged into the DIE-TRY. You will see the entire wave shape of the forming force as the press moves through its cycle.

Suppose you are having tooling stagger problem. With a strip chart recorder you can see exactly when each punch contacts the work piece. Suppose you are having trouble in a complex die. You can see the tonnage wave shape of each portion of the operation. Suppose you have a problem but can't decide if it is the press or the die. A check with a strip chart recorder can quickly isolate the problem. Suppose that snap-through is shaking a press severely. You see the snap-through and you can accurately measure it.

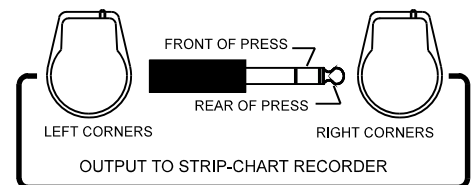

The tonnage levels of a fresh well-running die may be recorded on a strip chart. If you have trouble in the future, it is a simple thing to run a new chart and compare it to the old one. In most cases, the problem will be obvious. You might think that only experts could understand the information on strip charts. In a way you are right. However, almost every stamping plant has a least a few experts. The experts are the die setters, die makers, product engineers, machine maintenance people and others.

You don't have to be an electronic technician to understand strip chart recordings. In fact, the average electronic tech probably wouldn't understand what he was looking at on the strip chart. He wouldn't know presses or dies. However, show a good die-setter or die-maker a strip chart and very quickly they will explain most of what is going on in the press. In other words, understanding strip charts requires mechanical knowledge of presses and dies. Translating an electrical signal into a graphic display provides valuable information for your experts.

Suppose you are having trouble with a press and aren't certain whether repair or adjustment is necessary. A quick strip chart recording can answer your question about tie-rod, bearings, gibs and so on. If you have the sensors on the uprights, you will see tonnage level flatten out on a corner with a loose tie-rod. Improperly adjusted gibs will show chatter as tonnage zigzags at points in the press stroke. Bad bearings can show up as jumps in tonnage levels. The DIE-TRY instrument will provide strip chart tonnage signals for up to four press corners simultaneously. You may make sophisticated recordings even if you have only a single-channel recorder. Tonnage wave shapes seen on one press corner often will be similar on the other corners. Our service technicians carry only two-channel recorders. That doesn't seem to be a hardship if a customer wants to record tonnage information.

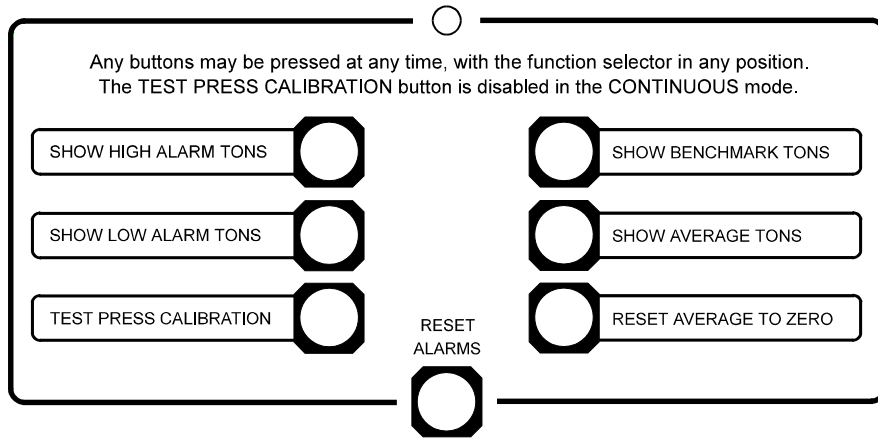

JOG / INCH

- This is "TRACK" operating mode.
- Meters will display the varying tonnage detected by the sensors. Tonnage peak will not be stored.
- Tonnage levels will not be stored.

SINGLE-STROKE

- This is "PEAK" operating mode.
- The tonnage levels displayed here are the highest reached any time during the press stroke.
- Press overload alarms are active.

CONTINUOUS

- Automatic monitoring position.
- Press overload and working tonnage alarms are active in this position.
- Alarms will trip if the working tonnage tolerances are exceeded.

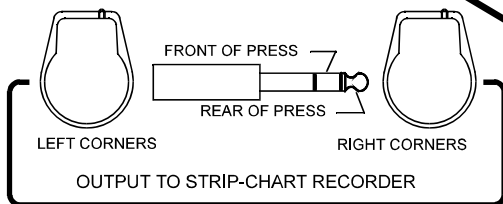

**TOLEDO
TRANSDUCERS
INC.**

HOLLAND, OHIO
U.S.A.

DIE-TRY FRONT PANEL CONTROLS AND FEATURES

OPERATING THE DIE TRY SERIES INSTRUMENT

INTRODUCTION

These are OPERATING INSTRUCTIONS. This is not a technical manual. These pages will explain, in rather simple terms, how to use the DIE-TRY portable tonnage instrument. It is not necessary to read these instructions from cover to cover. Use this as a reference booklet. There is nothing to memorize. The basic operating instructions are printed near all instrument controls. However, you can learn to make the DIE-TRY do helpful tricks if you merely browse through these instructions.

THE DIE-TRY INSTRUMENT

The front of the DIE-TRY instrument is divided into four sections:

- 1) Five digital displays show the press tonnage, press calibration numbers, diagnostic information, or the alarm trip points. What the meters show is controlled by the seven push buttons below the meters, by the function selector switch, and by various controls inside the DIE-TRY.
- 2) Below the digital display are seven push buttons. The bottom button is marked RESET ALARMS. Push this button if an instrument alarm is tripped.

TIP . . . Pushing the RESET button will NOT re-start the press. The press should be re-started in your normal manner.

Above the RESET button there is a group of 6 push buttons. Push any of these buttons to display a variety of information. These buttons may be pushed even while the press is producing parts.

TIP . . . The button marked TEST PRESS CALIBRATION displays the press calibration (CAL) numbers. This button is NOT active while the function selector is in the position marked CONTINUOUS. All other buttons are active in all positions of the function selector.

- 3) There is a three-position function switch to select the operating mode of the DIE-TRY. Information about each switch position is printed near the selector. The SINGLE STROKE position is the normal operating mode for press setup. Use the CONTINUOUS position if the instrument is to monitor parts production. The JOG/INCH position is preferred if you want to study the changing tonnage as a press is cycled slowly.
- 4) At the bottom left of the DIE-TRY are two covered dual circuit electrical signal jacks. You may plug a strip chart recorder or an oscilloscope into these jacks. You may record the actual press tonnage as the press goes through a cycle. The signals are the amplified but otherwise unchanged output of the sensors on each corner of the press.

TIP . . . The signals are the same as seen on the displays when the press cycles in the JOG/INCH mode. However, the DIE-TRY may be in any operating mode while making strip chart recordings.

OPERATOR CONTROLS

There are three types of operator and supervisor controls for this instrument:

1) FUNCTION SELECTOR

One outside control selects the operating condition of the DIE-TRY. This is a three-position function switch on the front panel.

SINGLE STROKE MODE:

The function selector should be in the SINGLE-STROKE (center) mode while the press is being adjusted. This is also the stand-by mode while the press is not running. Press overload alarms are active. **AT** Forming tonnage alarms are disabled. The displays will show the PEAK tonnage reached during the stroke.

CONTINUOUS MODE

When the press is running and making good parts, you may put the switch in the CONTINUOUS (right) position. This is the **AT** Automatic Target monitoring mode. The DIE-TRY will take a sample of the forming tonnage, calculate a new benchmark, and store it in memory. UPPER and LOWER working tonnage tolerance alarms are active in this position. Press overload alarms are also active in this position. Peak tonnage levels will be displayed on the DIE-TRY.

JOG/INCH MODE

The JOG/INCH operating mode is for die try-out. This is the "track" operating mode. The meters will display the varying tonnage detected by the sensors mounted on the press. This is very helpful during die try-out when you want to see how the tonnage varies while jogging or inching through the stroke. Only the press overload alarms are active in this mode. The **AT** alarms are not active.

2) UPPER AND LOWER ALARM CONTROLS

Two inside controls are used to set the alarm-tolerance band of the DIE-TRY. Use the UPPER ALARM CONTROL LIMITS control to set the alarms to trip on any forming tonnage that is too high. Use the LOWER ALARM CONTROL LIMITS control to set the alarms to trip on any tonnage that is too low. To set these controls, decide by what percentage the tonnage can increase or decrease without making a bad part or doing damage to the tooling.

You may change the UPPER and LOWER alarm controls even while the press is making parts and the function switch is in the CONTINUOUS position. As soon as you change the switches the instrument will automatically adjust the alarm trip points.

TIP . . After you make press or die adjustments that affect tonnage, you should put the switch to SINGLE STROKE and then turn back to the CONTINUOUS position. The instrument will then calculate a new target tonnage and store a new benchmark.

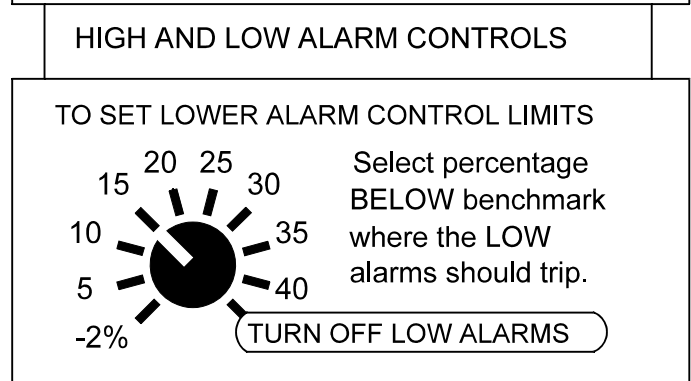
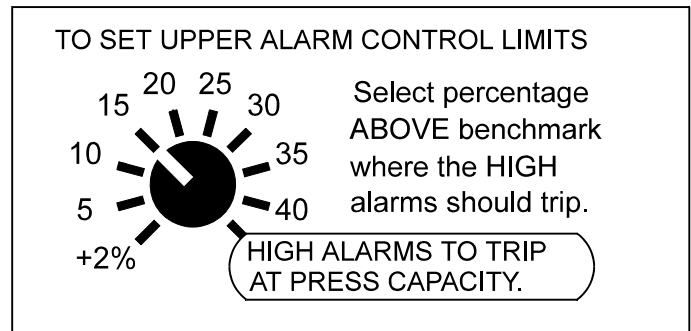

3) SUPERVISOR CONTROLS

On the rear of the door is a panel labeled SUPERVISOR CONTROLS. Normally, both switches are in the UP position (on).

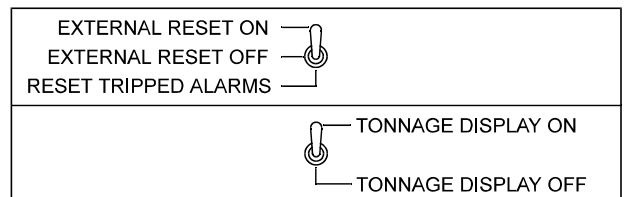

USING THE DIE-TRY INSTRUMENT FOR MONITORING PRODUCTION

STEP 1. Start with the function switch in the SINGLE-STROKE (center) position or JOG/INCH (left) position depending on which mode is required. The automatic alarms will be disabled. Only the press overload alarms will operate. Any tonnage shown on the displays will be the tonnage of the press stroke. The displays will update when the press is cycled.

TIP . . You may make a quick test to see if the DIE-TRY is working well. This test is not necessary every time you start a new job. If you periodically make the test you will gain confidence with the DIE-TRY. See the section titled “TO CHECK INSTRUMENT CALIBRATION”.

STEP 2. Make press adjustments and cycle the press. We suggest adjusting the press for lowest possible tonnage needed to make a good part. The four TONS displays will show the tonnage on each press corner on each press cycle. One or more displays will flash if the tonnage exceeds the trip point of the maximum-tonnage alarm. Push the RESET button to re-set tripped alarms.

STEP 3. When the press setup is finished, decide if the UPPER and LOWER alarms must be changed inside the DIE-TRY. It is not necessary to change the alarm controls if the new press setup has similar tonnage tolerance requirements as the previous job. For example, suppose the last job ran with an alarm-tolerance band of plus/minus 15%. You won't need to change the alarm controls if the new setup also will make a good part if the tonnage doesn't vary more than 15%.

STEP 4. Turn the function switch to the CONTINUOUS position when the press is running and making good parts. The **AT** (Automatic Target) alarms will immediately be active. You will have first-hit protection if you are using a TTI-2715 press-control box. The DIE-TRY will calculate a new average target tonnage during a short series of press strokes. It will then update the temporary benchmark tonnage. One or more displays will flash if an alarm trips. If the trouble does not need press adjustment you may leave the function switch in the CONTINUOUS position. For example, the material feed wasn't working just right. Cure the problem, push the RESET button, and then restart the press. If the press needs adjustment there is a good chance the forming tonnage will have changed. A new target tonnage (benchmark) should be established. In this case the DIE-TRY should be put into the SINGLE-STROKE position and then back to the CONTINUOUS (right) position. This will force the instrument to calculate a new target tonnage (benchmark) and replace the old one.

TIP . . There is a good chance that alarms will keep tripping until the press is up to speed and making good parts if you are re-starting the press in the CONTINUOUS mode. In this case, put the function switch to the SINGLE-STROKE (center) position until the press is running properly. Return the selector switch to the CONTINUOUS (right) mode. Your old benchmark will be lost when you leave the CONTINUOUS mode. A new benchmark will be calculated when you again enter the CONTINUOUS mode. The DIE-TRY cannot re-start the press even though the alarms are reset. After the alarms are re-set, you may start the press in your normal way.

TO CHECK INSTRUMENT CALIBRATION

When your instrument was installed, it was probably matched to the press by what is called press calibration. The press was forced to work near its rated tonnage capacity by impacting on calibrated load cells. Then, the instrument was adjusted to display the proper amount of the impact tonnage. When that was done, special calibration numbers were read from the instrument. These numbers were written on a label inside the instrument for future reference. The DIE-TRY will not display the proper calibration numbers if something in the system changes. You may check calibration whenever the instrument is in the SINGLE-STROKE mode. Stop the press and push the TEST PRESS CALIBRATION button. Read the CAL numbers from the displays.

Special calibration numbers for each press corner show up on tonnage displays as long as you hold the TEST CALIBRATION button. Compare the numbers to the ones recorded by the technician during the press calibration. If each calibration number is correct the DIE-TRY is still accurately calibrated. There might be a slight difference between the displayed numbers and the recorded CAL numbers.

TIP . . The CHECK CALIBRATION button is active only in the SINGLE-STROKE mode. It is disabled in the JOG/INCH and CONTINUOUS modes to prevent accidental alarms.

The amount the displayed CAL numbers differs from recorded CAL number approximately represents the error in the system. However, an error in the displayed calibration numbers does not affect the accuracy of the **AT** alarms. They are referenced to the benchmark tonnage and not to the tonnage span of the instrument. The **AT** alarms work on percent-of-tonnage-change and not on calibrated tonnage.

A QUICK CALIBRATION TEST

Here is a simple test to make if you have doubts about whether the DIE-TRY is still accurate:

STEP 1. Stop the press.

STEP 2. Have the function switch to the SINGLE-STROKE (center) position.

STEP 3. Press and hold the pushbutton marked TEST PRESS CALIBRATION.

STEP 4. Read the numbers that are displayed and compare them to the calibration numbers that were recorded for the instrument.

TIP . . The numbers may be wrong by a few percent and still not indicate a problem that needs immediate correction. Tonnage measurements will be wrong by the same percentage that the CAL numbers are wrong. For example, suppose the recorded calibration numbers were 100 tons per corner. Suppose the displays showed calibration-check numbers of 95 tons per corner. This is a 5% error. In this example, your individual tonnage measurements would probably be wrong by about 5%. Even though the calibration numbers are wrong, the **AT** part of the monitor will still work well. That is because the **AT** (Automatic Target) alarm trip-points are compared to the benchmark average tonnage and not to the actual tonnage level. Even if the actual tonnage is not accurate it is tonnage-deviation that is checked.

TO RESET TRIPPED ALARMS

A tripped alarm will cause one or more displays to flash. The pattern of the flashing shows where on the press bed the problem occurred and which alarm level caused press shutdown. Push the front panel RESET button to re-set tripped alarms. Tripped alarms may be re-set with the function switch in any one of the three positions.

Perhaps the alarms cannot be re-set by pushing the RESET button. Perhaps the front panel RESET button is disabled by the switch on the SUPERVISOR CONTROLS panel inside the DIE-TRY. In that case, the instrument must be opened to re-set the alarms at the supervisor control panel.

TIP . . It is NOT necessary to learn the meaning of the flashing pattern. The flashing is an aid to troubleshooting forming problems. The flashing pattern will usually be used by technicians.

ABOUT BENCHMARK MONITORING AND “AT” ALARMS

INTRODUCTION

The following pages explain how the DIE-TRY works. The DIE-TRY series tonnage instruments are very easy to understand and operate. In addition, they are very versatile and provide a broad range of helpful benefits. What you will find important is the ease with which the DIE-TRY can set up for both standard and special jobs. There are no keyboards to use. There is nothing to memorize. Operating instructions are printed near the operating controls. We made the DIE-TRY as automatic as possible. That doesn't mean that it has limited applications. It can do almost anything that can be done on any load monitor . . . and many things that others cannot do.

It is difficult to adjust a conventional load monitor every time a job is changed or the press is adjusted. There can be as many as eight different alarm trip points to calculate and as many as eight alarm-set controls to adjust. That is not the case with the DIE-TRY monitor. All calculating, memory storage, alarm adjustment and comparing is automatic. Just turn the front function switch to start the calculating and monitoring process.

ALARM LEVELS

There are two types of alarm levels built into the DIE-TRY instrument . . . Press-overload (CAPACITY) alarm and AT (Automatic Target) alarms.

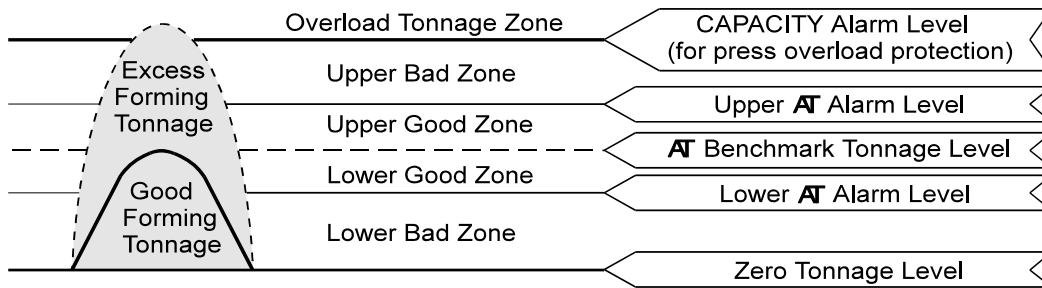

- 1) At the highest level are the maximum-tonnage alarms that are tripped by a press overload. These alarms are active in all operating modes. These alarm levels are usually adjusted when the press is first calibrated. It is not necessary to readjust these alarms unless you move the monitor to a different press.

TIP . . . The AUTO-CAL portion of the DIE-TRY instrument remembers the press-overload trip points for all presses it has been “introduced” to. The alarm trip points will be recalled when the press identity number is entered into the instrument.

- 2) There are AT alarms that will trip if the forming tonnage deviates too much from the target (benchmark) tonnage. The alarms are active only when the DIE-TRY is in the CONTINUOUS mode.

WITHOUT AT (Automatic Target) ALARM-SET

The following steps are to illustrate how difficult it is to adjust a common load monitor. The DIE-TRY uses a simple but highly sophisticated method of setting working tonnage alarm trip points. We call this method Automatic Target (AT). The following comparison emphasizes the importance of the AT alarm controls. The list shows the steps needed to change alarm levels for a typical load monitor without Automatic Target (AT) alarms.

- STEP 1.** Cycle the press and make good parts. Assume you have a four-display monitor on a straight-side press. Read and record the tonnage levels shown on the digital display for each press corner. The displays are probably changing with each press hit so try to calculate reasonable average tonnages.

Stop the press. Make the following calculations and adjust the alarm trip points.

- STEP 2.** Calculate the tonnage levels at which you want the high alarms to trip. For example, suppose a good part will be made as long as the tonnage on any corner doesn't go higher or lower than 15%. In this example, suppose the left front tonnage average was 75 tons. 15% of 75 tons is 11.25 tons. That means the left front high alarm trip point should be 86.25. The low alarm trip point would be 63.75.

- STEP 3.** In this example, the monitor would be set up so the displays show the high alarm trip points. Watch the left front display and adjust the left front high alarm to trip at 86 tons (or 86.25 tons).
- STEP 4.** Calculate the high alarm trip points for the other three press corners.
- STEP 5.** Adjust the high alarm trip points for the remaining three press corners.
- STEP 6.** Set up the monitor so the displays show the low alarm trip points. In this example you would watch the left front display and adjust the left front low alarm to trip at 63 tons (or 63.75 tons).
- STEP 7.** Calculate and adjust the low alarm trip points for the other three press corners.
- STEP 8.** Set up the DIE-TRY to monitor production.

Note . . It is my guess that you didn't read all of the adjustment steps. Over the years we have found that most people don't perform the tedious steps every time they change or adjust the press or tooling. Usually they adjust the monitor to some high tonnage that won't give them frequent press stoppages. For this reason we developed the **AT** method of alarm adjustment.

WITH AT (AUTOMATIC) ALARM-SET

Only the following are the steps needed to set up a DIE-TRY with **AT** alarms.

- 1) Decide the tolerance band that will assure you of good parts.
In this example, suppose you decide on plus/minus 15%.
- 2) Turn one UPPER ALARM switch to 15%.
- 3) Turn one LOWER ALARM switch to 15%.
- 4) Turn the function selector to CONTINUOUS mode.

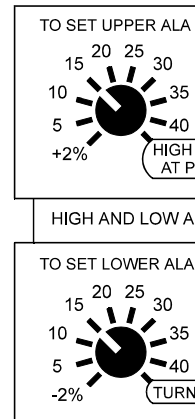

CHOOSING AT ALARM LEVELS

It is rather simple to decide what percentage of tonnage change (tonnage tolerance) is acceptable. The press setup person usually finds the tonnage band for making good parts when they adjust the press for optimum quality. That percentage is set into the monitor with the ten-position UPPER and LOWER alarm control switches. Fortunately, we find that most jobs, on a particular press, will run with the same percent-change tolerance band even though the actual tonnage may vary quite a bit.

DECISIONS

- ? Is the press being adjusted? The DIE-TRY should be in the SINGLE-STROKE operating mode.
- ? Do you want to observe tonnage levels as you slowly cycle the press? Put the front-panel function selector in the JOG/INCH position.
- ? Has the die-setter finished the press adjustment and good parts being made? If so, it is time to put the function switch in the CONTINUOUS mode for monitoring parts production.
- ? Is it necessary to stop and re-start the press for some reason? The DIE-TRY may be left in the CONTINUOUS mode if no significant press adjustments will be made.
- ? Has an alarm been tripped? If so, cure the problem and press the front RESET button.

DIGITAL DISPLAYS ON THE FRONT PANEL

The digital displays are simple to understand. There is one green digital display for each corner of the press plus a total display. Green display elements were chosen because of their high visibility in low-light conditions. The



displays also show CAL (Calibration) numbers and alarm trip-points when appropriate buttons are pushed. A complete instrument diagnostic program is built into the DIE-TRY instrument. The displays are tested for bad elements when the diagnostic program is initiated. In addition, the diagnostic program checks all critical circuits of the instrument. The displays will then show if problems exist.

THE FUNCTION SELECTOR

The function selector is a three-position switch on the front of the DIE-TRY. It selects the operating mode of the instrument. The operating instructions are printed right at each switch position.

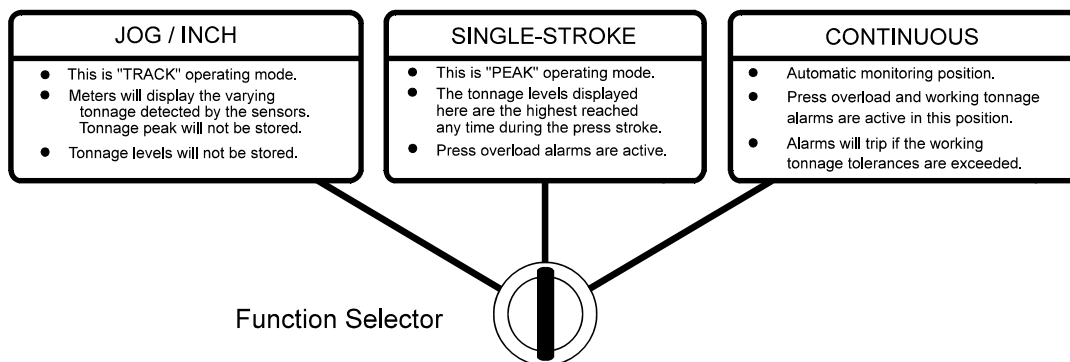

SINGLE-STROKE MODE

The SINGLE-STROKE mode is used by the die setter during press setup and adjustment. The only alarms that are operational are the maximum-tonnage overload alarms. All **AT** working-tonnage alarms are inhibited. The die setter won't need to reset alarms repeatedly (unless he continuously overloads the press).

CONTINUOUS AUTOMATIC MONITORING

The right switch position on the function selector is the normal **AT** automatic monitoring mode. The DIE-TRY will erase the old benchmark tonnage and calculate a new one. The maximum-tonnage press overload alarms will be operational. In addition, all **AT** alarms become active. You have first-hit protection the instant the switch is turned to CONTINUOUS. The instrument will re-calculate and update the average forming tonnage benchmark after a series of press cycles.

JOG/INCH MODE

The JOG/INCH mode (left position) is valuable to the die setter during press setup and adjustment. The only alarms that are operational are the maximum-tonnage overload alarms. Use this position while running the press slowly so you can see tonnage changes as the press moves through the stroke. This is the "TRACK" operating mode.

FRONT PANEL PUSHBUTTONS

There are seven sealed “membrane” type pushbuttons on the front panel. One of these is the alarm RESET button. The other six buttons are used to display a variety of information at any time. Any of the seven buttons may be pressed at any time without causing an alarm.

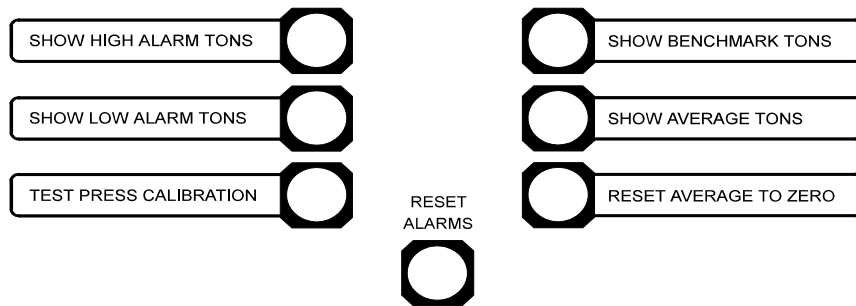

1) TEST PRESS CALIBRATION

Push this button to check the accuracy of the tonnage system. We feel that anyone should be able to check DIE-TRY calibration quickly and easily. Checking calibration on most other monitors is a tricky job usually done only by technicians.

2) SHOW HIGH ALARM LIMITS

Push the SHOW HIGH ALARM TONS button to display (in tons) all UPPER **AT** (Automatic Target) alarm trip points.

3) SHOW LOW ALARM LIMITS

Push the SHOW LOW ALARM TONS button to display (in tons) all LOWER **AT** alarm trip points.

4) SHOW BENCHMARK TONS

Push this button to show the stored benchmark (target) tons for each corner of the press. This is important if you want to know the original setup tonnage.

5) SHOW AVERAGE TONS

Push this button to view the average tons during a die try-out or production run. The DIE-TRY will continue calculating and remembering the average tonnage until the RESET AVERAGE TONNAGE button is pressed. This is handy to show how consistent a job is running.

6) RESET AVERAGE TO ZERO

The average-tons memory is cleared to zero when this button is pushed. Averaging resumes on the next press stroke.

ALARM RESET BUTTON

Push this button to reset all tripped alarms. The alarm RESET button is unique. A Supervisor may disable it if he wants to. Usually the RESET button is active and will re-set all tripped alarms during routine monitoring. However, suppose a supervisor wants to be called every time there is a press shutdown. There is a toggle switch inside the DIE-TRY to disable the outside RESET button. The supervisor may disable the outside RESET button and make only the inside one active. Tripped alarms may then be re-set from the SUPERVISOR CONTROLS panel inside the instrument.

TIP . . . Even if the RESET button is disabled for automatic monitoring it will ALWAYS be active for the die setter if he needs it in the JOG/INCH or SINGLE-STROKE mode.

TO SHOW MAXIMUM-TONNAGE (CAPACITY) ALARM TRIP POINTS

Press and hold the RESET button to display the high-level press-overload alarm trip points.

ANALYTICAL SIGNAL OUTPUTS

Technical people can use an oscilloscope or a strip chart recorder to observe and record how the forming tonnage changes throughout the press stroke. It is surprising how easy it is to spot forming problems when you see the tonnage wave-shape drawn on paper.

There are two covered signal output jacks on the front of the monitor. An oscilloscope or strip chart recorder may be plugged into these jacks to watch the analog tonnage signal from the sensors. This allows press or die problems to be analyzed rather easily. The signal from the sensors faithfully represents the tonnage changes in the press frame. It is usually called the “track” signal. The signal is amplified but otherwise not altered (1 ton = .001 volt).

FEATURES INSIDE THE ENCLOSURE

ELECTRICAL SAFETY

The DIE-TRY is inherently electrically safe with the door open. Any potentially dangerous voltages are well covered. Critical adjustments and controls are located inside compartments, away from the fingers of curious people. There is no reason for anyone but a technician to remove the compartment covers and make adjustments. It is a simple thing to seal the compartment cover screws if there is a security problem.

The digital display printed circuit board is mounted on the back of the enclosure door. There is a metal cover over that circuit board. On the metal cover are numerous switches. These switches control the **AT** alarm trip points and AUTO-CAL. Full operating instructions are printed near the controls. Anyone with the authority to make routine decisions about the press operation can easily adjust the alarm selectors.

SUPERVISOR CONTROLS

The DIE-TRY has a toggle switch mounted on the SUPERVISOR CONTROLS panel inside the enclosure. This control helps supervisory or technical people control the press operation more closely. The toggle switch controls whether the front panel RESET button is active or not. The supervisor can disable the outside RESET button to know every time there is an alarm. The Supervisor must be called to re-set tripped alarms. They can be re-set from inside the enclosure.

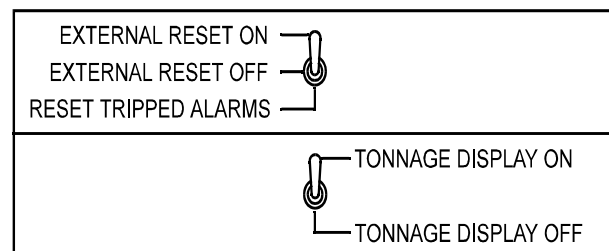

UPPER and LOWER ALARM CONTROLS

There is an UPPER alarm and a LOWER alarm for each press corner. They are automatically adjusted the appropriate tonnage when the function switch is put into the CONTINUOUS position. The controls may be set 2%, 5%, 10%, 15%, 20%, 25%, 30%, 35%, or 40% over and under the average-tonnage (setup tonnage) benchmark. Most customers usually set these selectors at perhaps 15%, 20%, or 25% and let them alone.

TO STORE CALIBRATION NUMBERS WITH AUTO-CAL

The AUTO-CAL feature eliminates the complicated procedures needed by all other portable systems. Calibration settings for each press are stored in non-volatile memory and easily recalled. All the shortcomings of trim-pots are eliminated. AUTO-CAL allows you to store up to 100 different sets of calibration settings.

The DIE-TRY instrument can store CAL number adjustments for up to 100 4-column presses. Only TOLEDO instruments have this feature. CAL (calibration) numbers are generated when the press is calibrated. Generally, the calibration procedure is done only once per press. *For presses with capacities less than 400 tons, read appendix A before proceeding to the steps listed below.*

STEP 1. There is a DIP (Dual Inline Package) switch that must be turned on to enter new CAL numbers into the AUTO-CAL memory. There is a printed circuit board under the supervisor control panel. Locate DIP-switch #8 on the outer edge of the PC board. Turn the switch to the ON position.

TIP . . . It is not necessary to remove the metal cover. The bottom DIP-switch is #8. A small screwdriver can be used to flip (away from you is the ON position) the switch. This procedure is required since calibration numbers are usually stored only one time per press.

STEP 2. SELECT PRESS IDENTITY NUMBER. This is a 2-digit number (00-99) under which you wish to store calibration settings for a press.

STEP 3. SET PRESS CAPACITY IN TONS. Capacity is the total maximum allowable tonnage for a press. Use the four selector switches on the bottom of the AUTO-CAL panel. For example, if you are setting the capacity for a 500 ton press, select 0 5 0 0. When this is done, push the CAPACITY button. The press capacity is now stored.

Note: For 2-channel applications using the ACK-2 kit, the DIE-TRY requires a capacity value that is 2 times the actual press capacity. Example; for a 300 ton press, set the capacity value to 0 6 0 0.

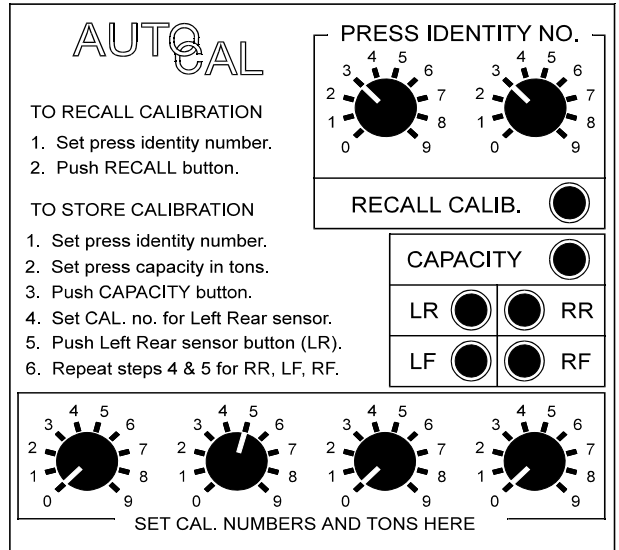

STEP 4. SET THE CALIBRATION NUMBER FOR THE LEFT REAR SENSOR

Use the four selector switches on the bottom of the AUTO-CAL panel. Press the LR button when this is done.

STEP 5. REPEAT STEP #4 for Right Rear, Left Front, and Right Front. (RR, LF, RF)

Note: For 2-channel applications using the ACK-2 kit, enter the Left Sensor calibration number using the LR button and the Right Sensor calibration number using the RR button. You must also enter the values, (0 0 0 1), for the LF and RF buttons and connect a precision star bridge connector to the unused channels. Please contact Toledo Transducers for additional information and parts.

TIP . . After the calibration settings and press capacity for a press have been stored, you may choose another press identity number and repeat steps 2 through 5.

STEP 6. Return DIP-switch #8 to the OFF position.

TO RECALL A CALIBRATION

After calibration and press capacity numbers have been stored in the AUTO-CAL memory, they may be recalled at any time. This is a very easy procedure.

STEP .1 SET PRESS IDENTITY NUMBER. (00-99) Enter the press identity number that was established during press calibration.

STEP 2. PUSH RECALL CALIBRATION NUMBER. When this is done, each channel is balanced and the span is properly adjusted. This process takes about one second.

TIP . . Always recall calibration settings WITH THE SENSORS CONNECTED. You may view the stored settings at any time. Press the RECALL CALIBRATION without the sensors connected.

SELECTING INSTRUMENTS AND ACCESSORIES

The DIE-TRY instrument is a model DT4BTR. It is for use with C-frame and straight side presses. Included with the instrument is one TTI-4050 sensor interface cable with special high quality connectors on both ends. Also included is one special type TTI-4048 power cable for connecting the instrument to 115 VAC.

SENSOR INTERFACE CABLE
TTI-4050
(One cable standard with instrument)

A.C. POWER CABLE
TTI-4048
(One standard with instrument)

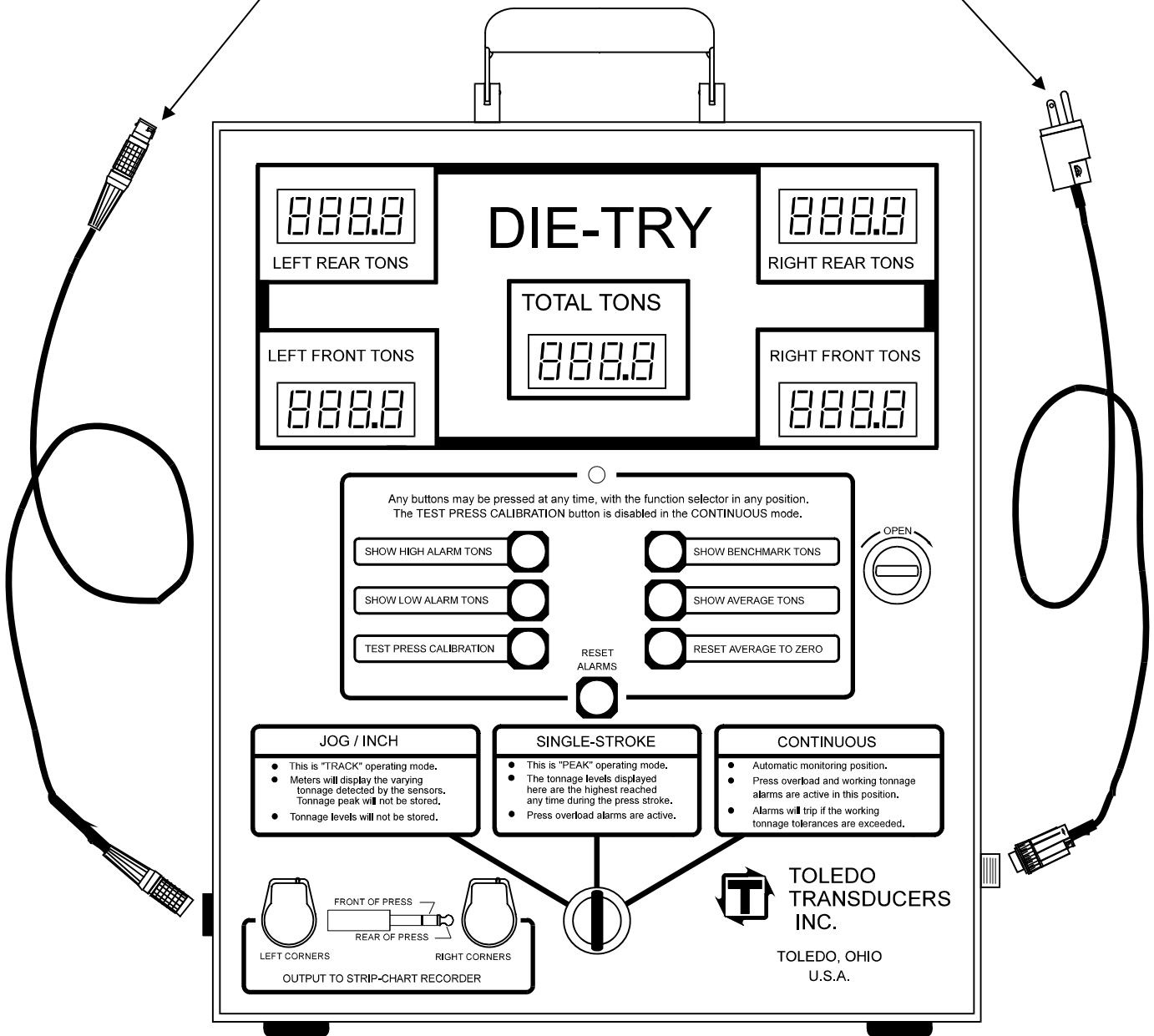

DIE-TRY Tonnage Meter Model DT4BTR

TWO STANDARD SENSOR PACKAGES

One ACK-2 kit is needed for each C-frame press or other 2-channel application. ACK-2 means “AUTO-CAL KIT for two sensors.” One ACK-4 kit is needed for each straight side press or other 4-channel application. ACK-4 means “AUTO-CAL KIT four sensors.” Either kit contains either two or four sensors, hardware for weld-pad mounting, four protective enclosures, covers and hardware, one model TTI-2716 sensor interface box (sensor terminal box).

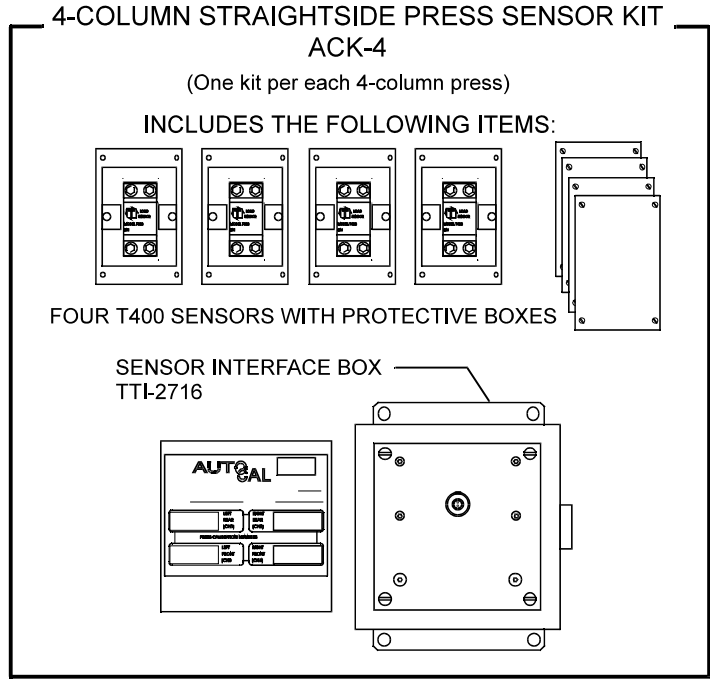
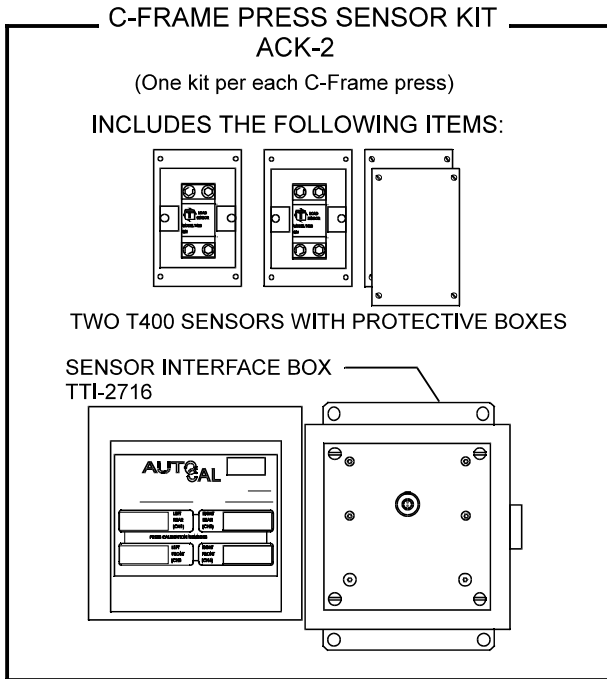

FOR PRESS CONTROL

A type TTI-2715 terminal box is necessary if the DIE-TRY is used to stop the press. The TTI-2715 box should be connected to a clean source of 115 VAC and to the press control circuits. The standard TTI-4048 power cable cannot be used because that cable doesn't contain shutdown wires. A TTI 4049 power and shutdown cable is needed for each instrument. This cable plugs into the TTI-2715 terminal box for AC power and control press stopping.

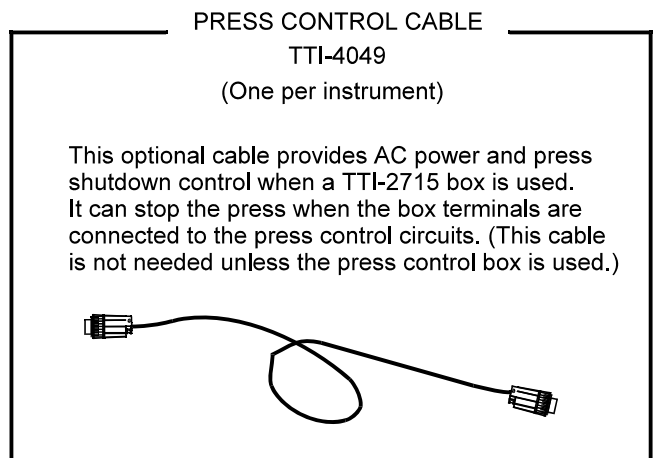
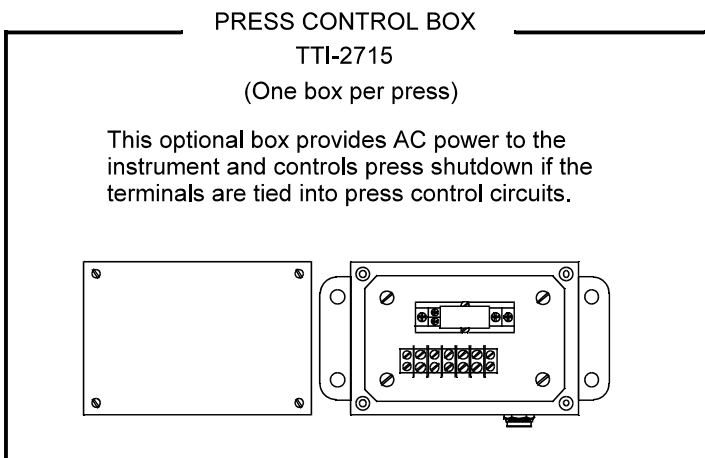

Using The Die Try For Calibration (All examples use a 500 ton press)

For presses with capacities less than 400 tons, read appendix A before proceeding to the steps listed below.

- Step 1.A.** Verify sensor locations. (Left Rear = Ch 1, Right Rear = Ch 2, Left Front = Ch 3 and Right Front = Ch 4.)
- B.** Torque all sensors down to 150in/lbs. (12.5 ft/lbs).
- C.** Make sure all the sensors and shields are terminated correctly in the junction box mounted on the press. (ACK Box).

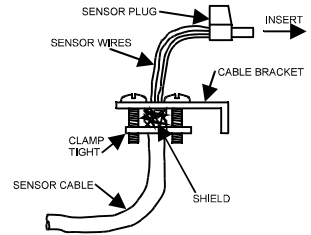

- Step 2.A.** Turn the #8 DIP-switch “on” by pushing it backward toward the middle of the board (This will allow you to enter data)

Dip-Switch #8

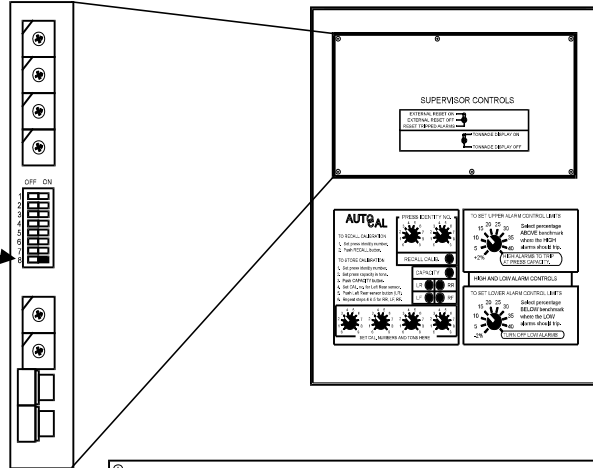

- Step 3.A.** Switch the Supervisor Controls in the inside panel to “EXTERNAL RESET ON”

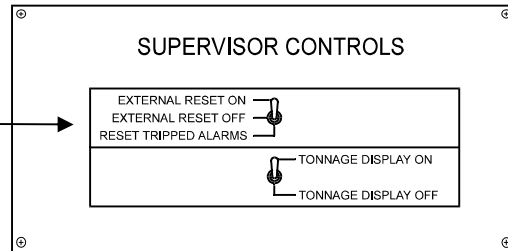

- Step 4.A.** Dial in the press ID number.

B. For 500 ton press dial in 0500

C. Press the CAPACITY button.

D. Press the RECALL CALIBRATION button

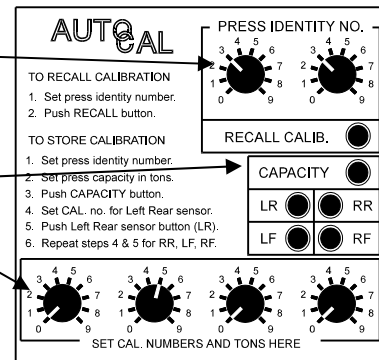

E. Press RESET ALARMS to check your Capacity.

RESET ALARMS



- Step 5.A.** Find the shut height of your press.
(Note: Incorrect Shut height settings can cause serious damage to your press.)
- B.** Determine the amount of space you need with you load cells.
- C.** Place the load cells on the bed of your press symmetrically on the solid steel spacers you have provided.
(Note: The spacers must be able to support the total tonnage of your press.)

- Step 6. A.** Make sure your first cycle will miss the load cells by 1/8 inch. Then cycle the press (carefully). Increase tonnage cycle after cycle until tonnage reaches capacity. Adjusting your shut height .001 inches generally increases the tonnage around 1 ton.

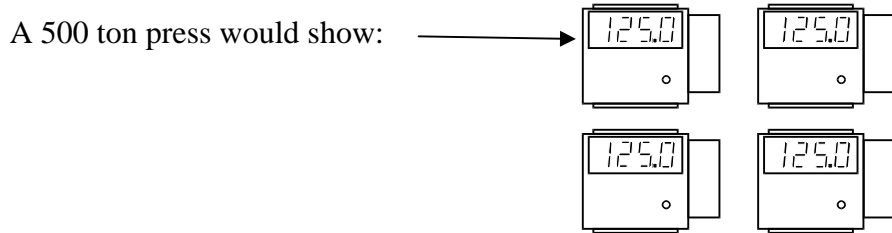

- Step 7. A.** Dial in a arbitrary calibration number of 70 in each channel by dialing “0070.” (This calibration number is simply a starting point.)

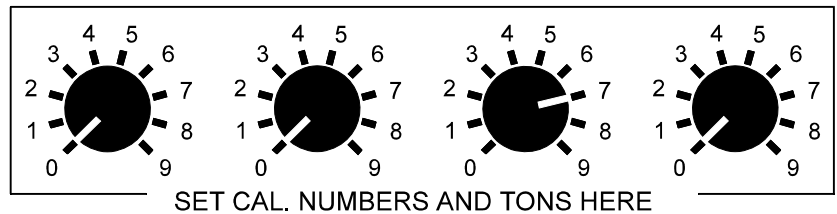

- B.** Then press LR, RR, LF, RF

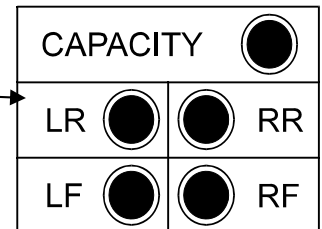

- C.** Then press “RECALL CALIBRATION”

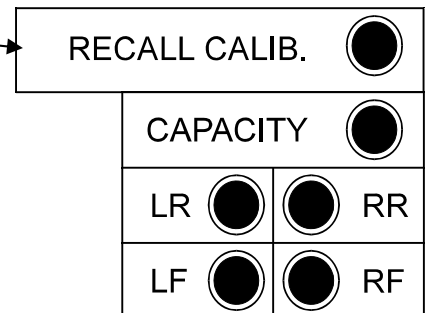

Step 8. A. Press RESET ALARMS (front cover.)



B. Cycle the press and record the tonnages.
(Example = 500 ton press)

Cells

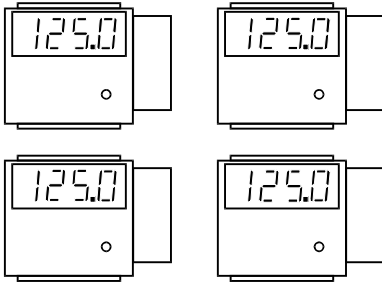

Monitor (Typical first reading)

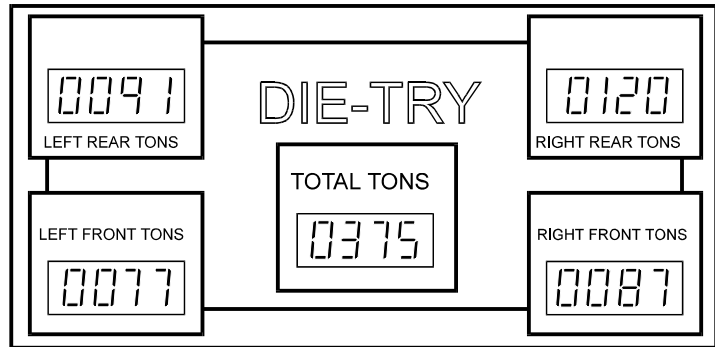

C. Calculate to get the true calibration numbers from your Die-Try tonnage reading
Use this formula for calculations:

$$\text{Load cell \#} / \text{Monitor \#} \times \text{Old Cal \#} = \text{New Cal \#}$$

(Example: To calculate the Left Rear corner: The Load Cell = 100, LR = 91, the old (arbitrary) cal number is 70.

Therefore: $100 / 91 \times 70 = \boxed{77}$

D. To enter the new calibration number Dial 0077.

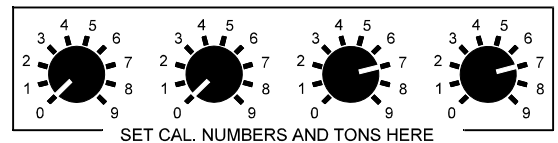

Press LR

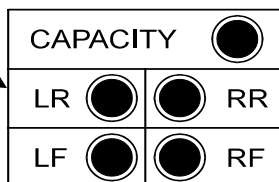

Press Recall Calibration

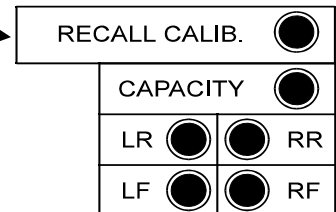

Follow **C** and **D** for RR, LF and RF.
Then press "RESET ALARMS."

If your tonnage values do not match go through **Step 8** again.

Step 9 . A. Press TEST PRESS CALIBRATION on the front cover.

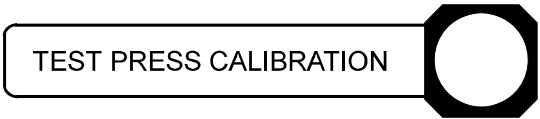

Record the calibration numbers on the junction box mounted on the press. This is the ACK Box that your DIE-TRY is plugged into. These calibration numbers will go with this press ID#.

Step 10. A. Now switch “off” the #8 DIP-switch. This will prevent any new data to be entered at this press ID number.

B. Conduct a linearity check by raising the shut height in small increments and cycle the press. You will see the accuracy of the unit at different tonnage ranges.

C. Record values. Chart the graph on the calibration sheet.

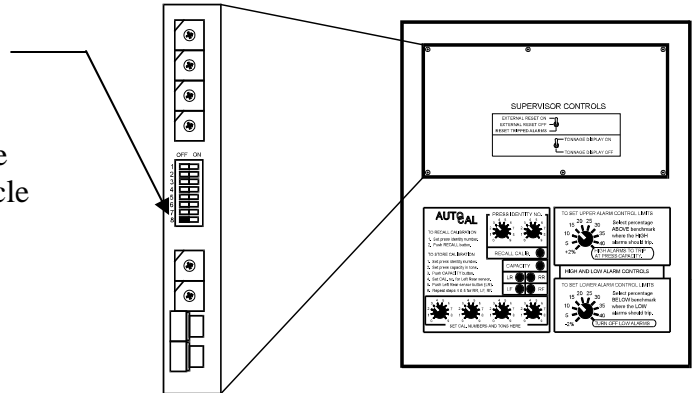

Step11. A. Complete the calibration sheet and documentation.

(Note: Remember that the Press ID number will save that calibration setting. Never use the same ID number twice.)

(Warning: Please, never make any gain or balance adjustments inside the monitor. These settings are pre-set by Toledo Transducers Inc. Any change to these settings will cause incorrect readings and will void your warranty.)

Appendix A

When using the DIE-TRY portable tonnage monitor on presses with tonnage capacities less than 400 tons, it is necessary to set the capacity value to four digits and to ensure that the decimal point position is set to correspond with the appropriate capacity value.

To enable a one or two-place decimal point on the digital displays, locate the bank of DIP-switches labeled SW305 on the left edge of the circuit board beneath the supervisor control panel. See figure below.

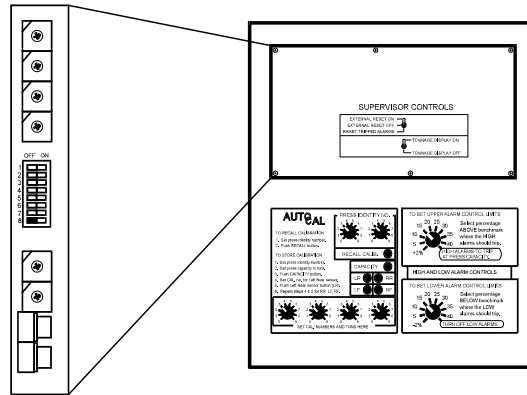

The number of decimal places may be set to 0,1,2 or 3 using switches 1 and 2 in the bank. Set the switches as follows for the number of decimal places desired:

SW305 1 & 2

9999 = 1 OFF 2 OFF
999.9 = 1 ON 2 OFF
99.99 = 1 OFF 2 ON
9.999 = 1 ON 2 ON

After setting the appropriate decimal place the unit is ready to store press capacity and calibration numbers. **Important:** When dialing in the values for capacity and calibration with the decimal point enabled, you must adjust the digit places to be to the left of the decimal point.

Examples:

For a 300 ton press, the capacity would be set on the AUTO-CAL control panel to 3 0 0 0 with a one decimal place enabled by having turned on DIP-switch #1 of SW305. The displayed capacity will be “300.0”. The calibration digits are also left justified when dialed in, so a CAL # of 68 would be dialed in as 0 6 8 0 and displayed as “068.0”.

For a 30 ton press, the capacity would be set to 3 0 0 0 with a two decimal place enabled by having turned on DIP-switch #2 of SW305. The displayed capacity will be “30.00”. The calibration digits are also left justified when dialed in, so a CAL # of 23 would be dialed in as 2 3 0 0 and displayed as “23.00”.